

Kasvihuoneen kokoamisohjeet

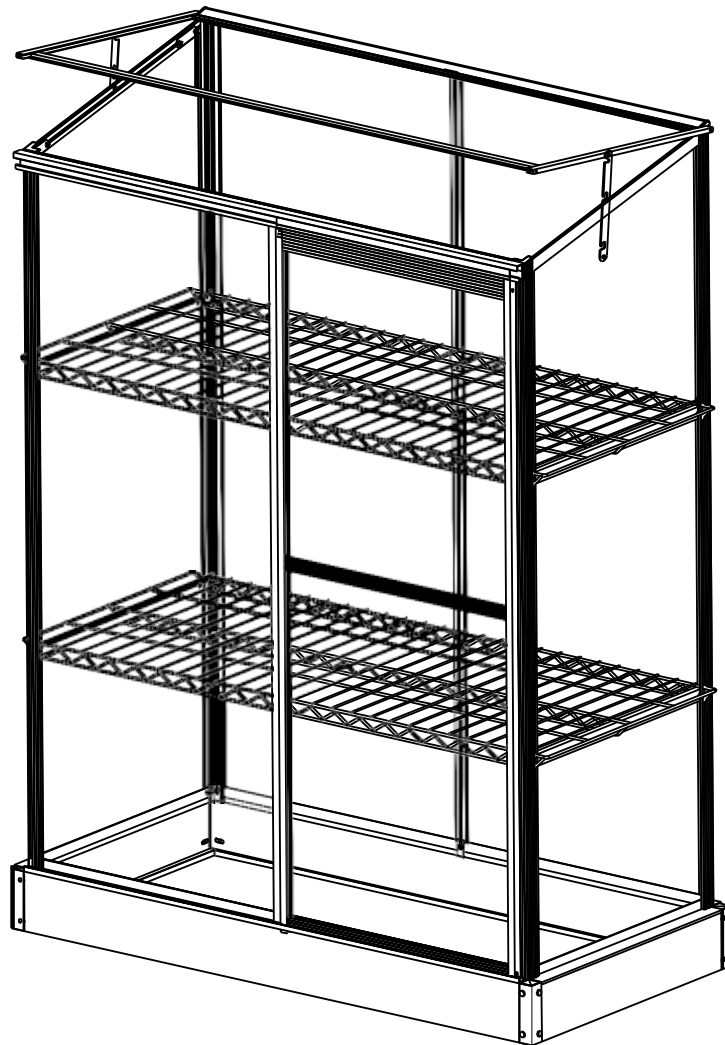

SNGH-K

TÄRKEÄÄ

Lue nämä ohjeet huolellisesti ennen kuin aloitat kasvihuoneen asentamisen.

Varmista, että kaikki osat ovat tallessa ja ohjeenmukaisia. Määrät on lueteltu ja asennus kuvattu tarkasti jokaisen vaiheen mukaan.

Noudata asennusohjeita tarkasti. Älä kiristä osia kokonaan ennen kuin polykarbonaattilevyjen asennus on täysin valmis.

Säilytä ohjeet.

TURVALLISUUS

Suosittellemme käyttämään suojakäsineitä asennuksen aikana.

Älä yritä asentaa kasvihuonetta tuulisessa tai märässä ympäristössä. Älä kosketa alumiiniprofiililla virtajohtoja.

Käytä aina kenkiä ja suojalaseja, kun käsittelet puristettua alumiinia.

Hävitä kaikki muovipussit ja pidä ne poissa pienten lasten ulottuvilta.

Kasvihuone on sijoitettava ja kiinnitettävä tasaiselle pinnalle.

Älä nojaa kasvihuoneeseen rakentamisen aikana. Pidä lapset loitolla kokoamisalueelta.

Älä sijoita kasvihuonetta sellaiselle alueelle, jossa huone altistuu kovalle tuulille. Älä yritä asentaa kasvihuonetta, jos olet väsynyt, lääkkeiden tai alkoholin vaikutuksen alaisena tai jos sinulla on taipumusta huimauskohtauksiin.

Jos käytät askeltikkaita tai sähkötyökaluja, varmista, että noudatat turvallisuusohjeita.

Kuumia esineitä, kuten äskettäin käytettyjä grillejä, puhalluslamppuja jne. ei saa säilyttää kasvihuoneessa.

Varmista, ettei maassa ole putkia tai kaapeleita ennen kuin asetat koukkuja.

YLEISIÄ OHJEITA

Kokoaminen koostuu useista vaiheista. Asennus kestää vähintään puoli tuntia.

Valitse aurinkoinen paikka tasaisella maalla kaukana riippuvista oksista.

Jos asennat kasvihuoneen suoraan vankalle betoniperustalle, käytä metallisen alustan valmiiksi porattuja reikiä.

Osat on tarkistettava ja pidettävä lähettyvillä. Pidä kaikki pienet osat (ruuvit jne.) astiassa, jotta ne eivät joudu hukkaan.

Huomaa, että ovi on saranoitu oikealta puolelta ja siksi avautuu oikealle. Pidä katto puhtaana lumesta ja lehdistä.

HUOLTO

Kun kasvihuone vaatii puhdistamista, käytä mietoa pesuainetta.

Älä käytä asetonia, hankausaineita tai muita pesuaineita kirkkaiden osien puhdistamiseen.

VAADITTAVAT TYÖKALUT JA VARUSTEET





Silikoni ja silikonityökalu, reikätyökalu, ristipäämeisseli, tikkaat.

Mittanauha, isokokoinen vasara, sakset.



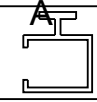

Työkäsineet, pora, vesivaaka, voiteluaine, muovi- tai kuminuija, 2 mm:n poranterä.

Jos tarvitset apua, pyydä ammattilaista avuksesi.

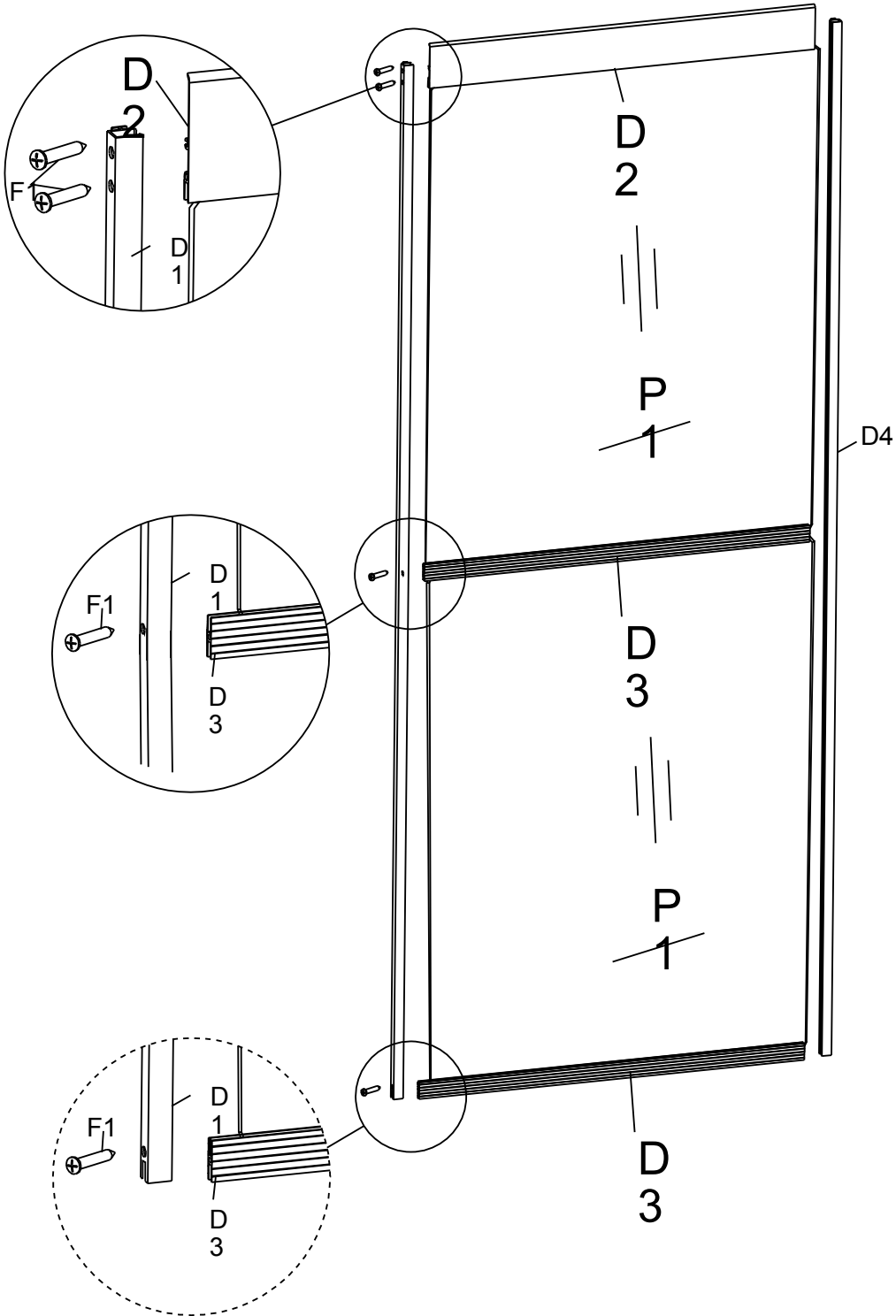
OVI

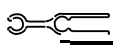
OS	N R	Mä rä
 A	9	1
	10	1
 4D	4	1
 2	2	2
 D3	F 1	8

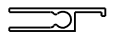

OSA	NRO	Määrä
	W1	1
	W2	2
	W3	1
	P2	1
	F2	6

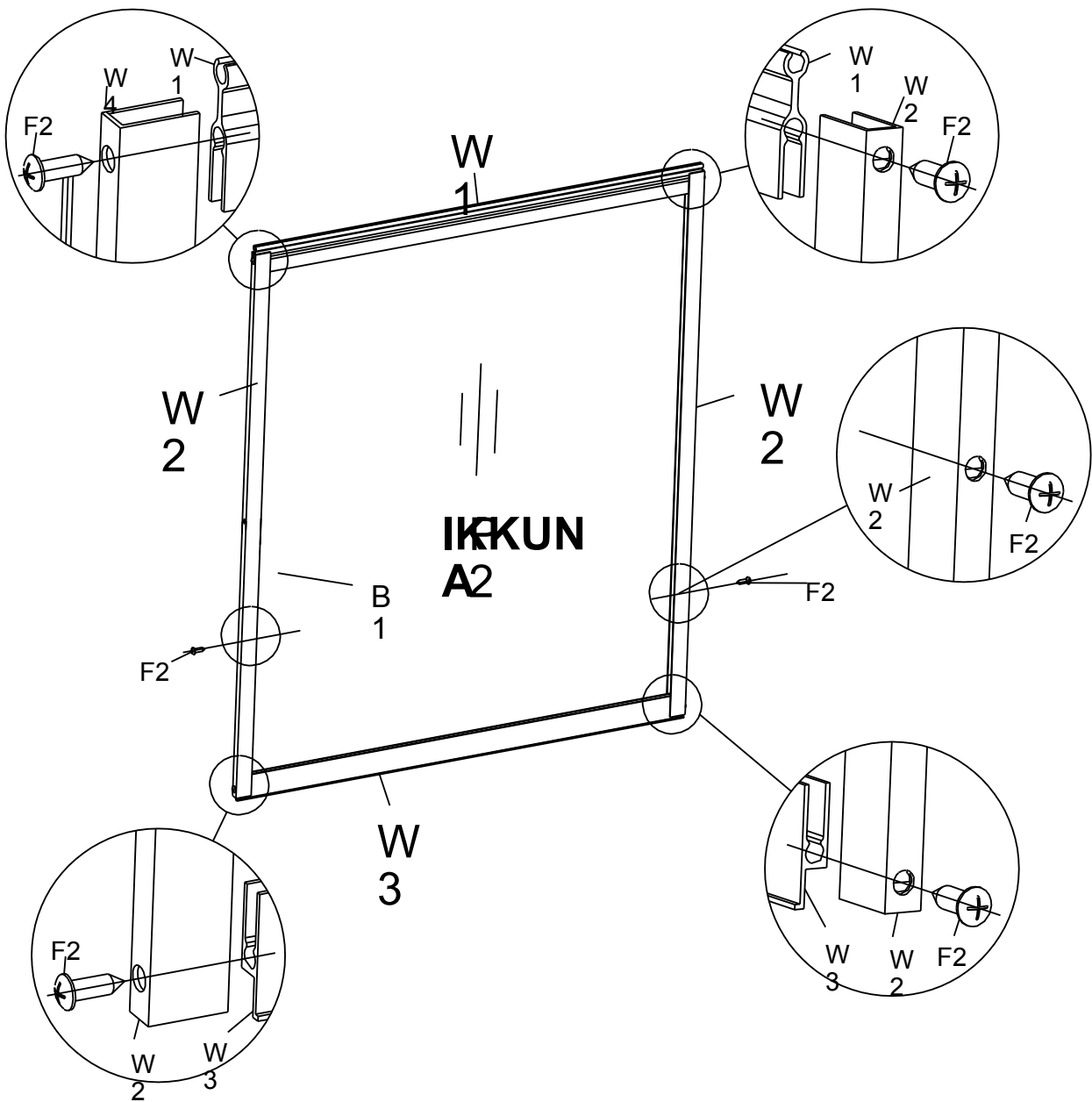

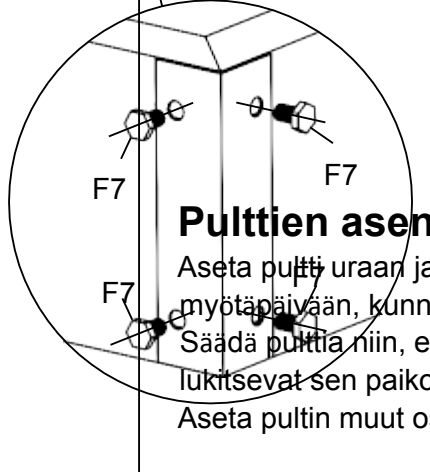
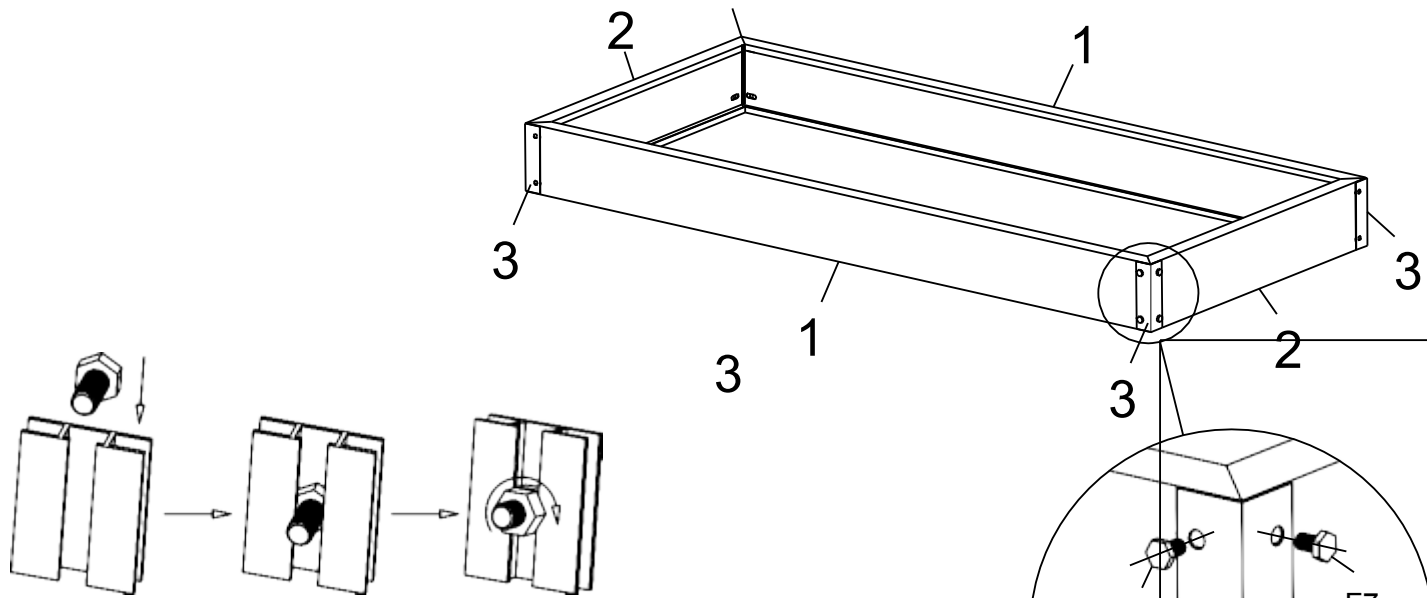





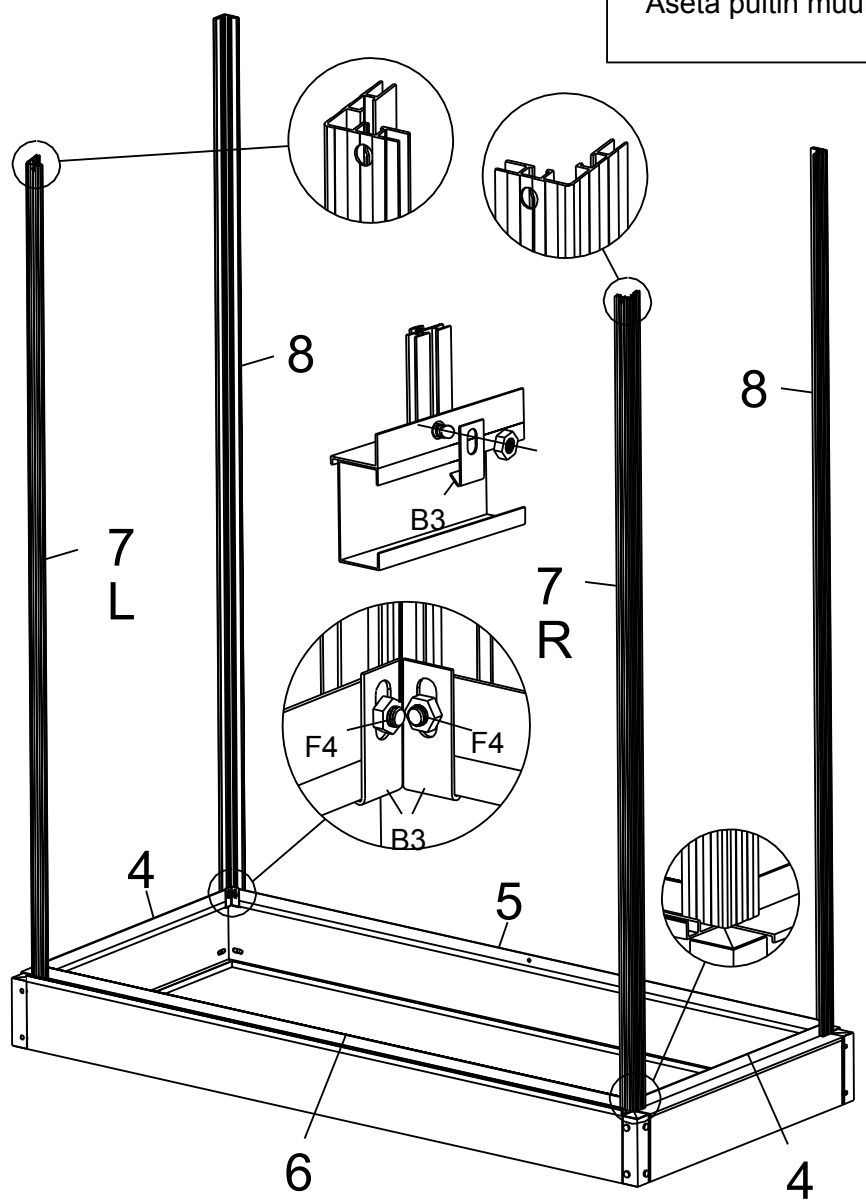

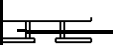
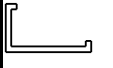

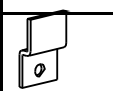
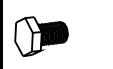

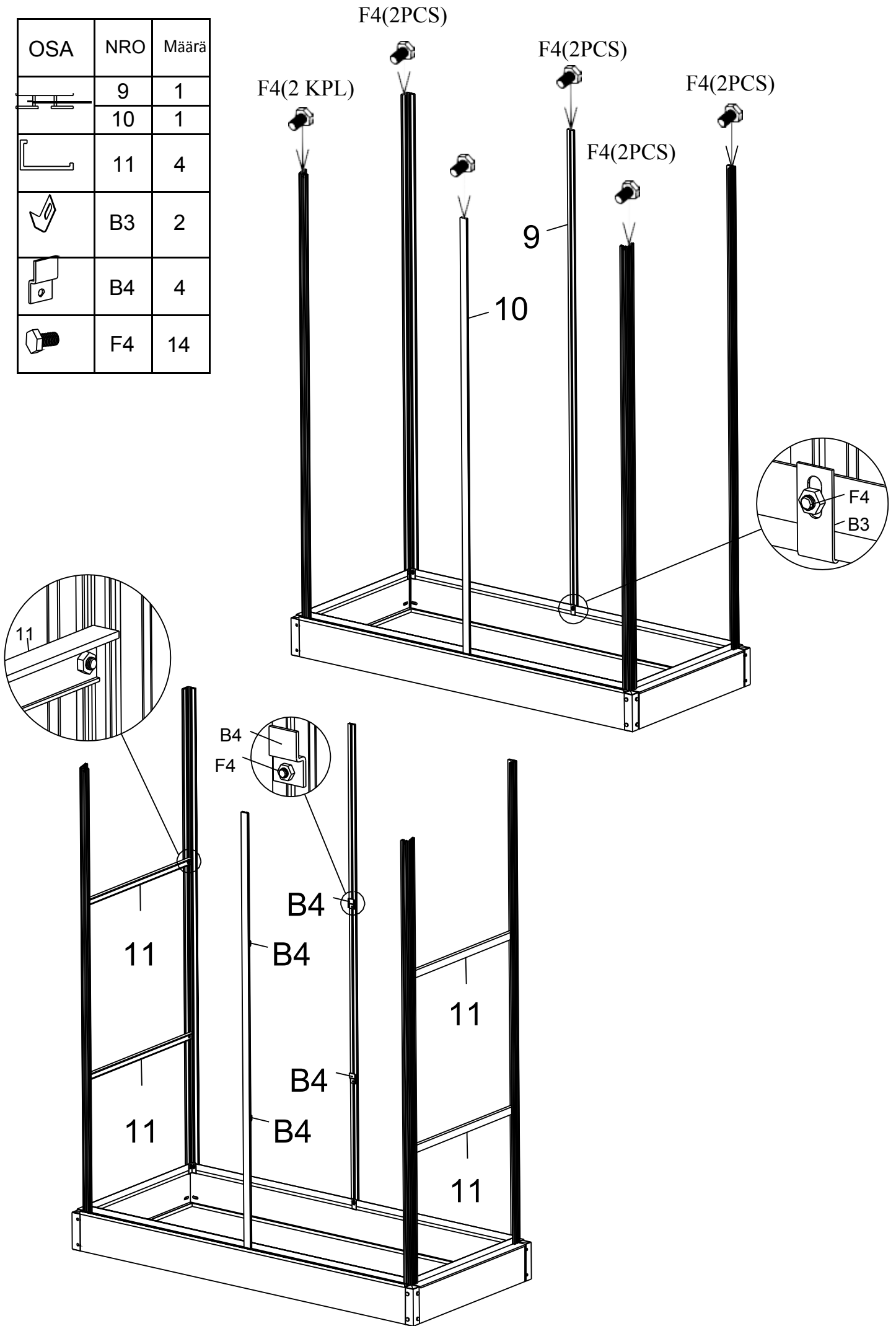
Pulttien asennus
 Aseta pultti uraan ja
 myötäpäivään, kunne
 Säädä pulttia niin, et
 lukitsevat sen paiko
 Aseta pultin muut os

OSA	NRO	Määrä
	1	2
	2	2
	3	4
	4	2
	5	1
	6	1
	7R	1
	7L	1
	8	2
	B3	8
	F7	16
	F4	8





OSA	NRO	Määrä
	9	1
	10	1
	11	4
	B3	2
	B4	4
	F4	14

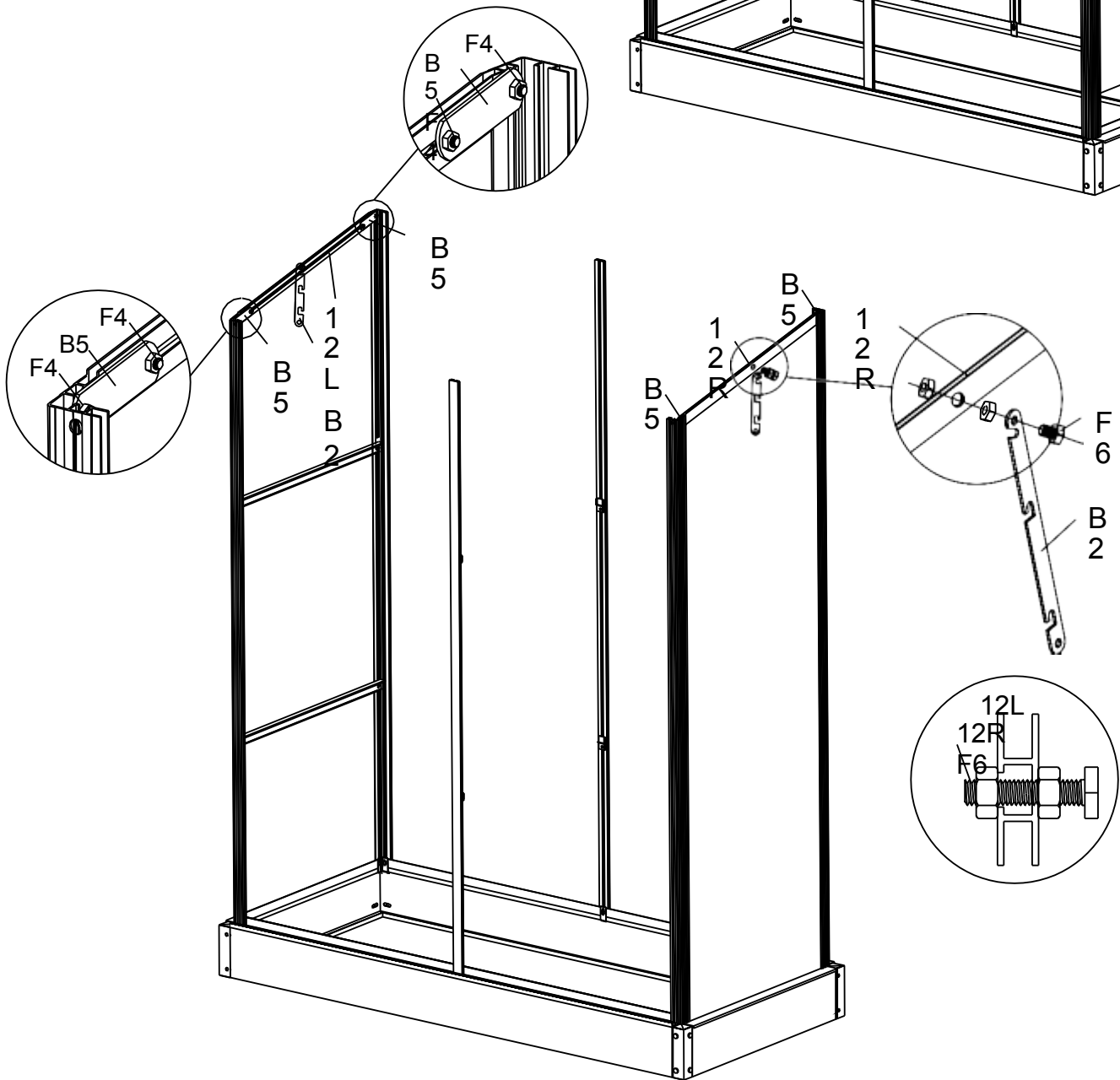
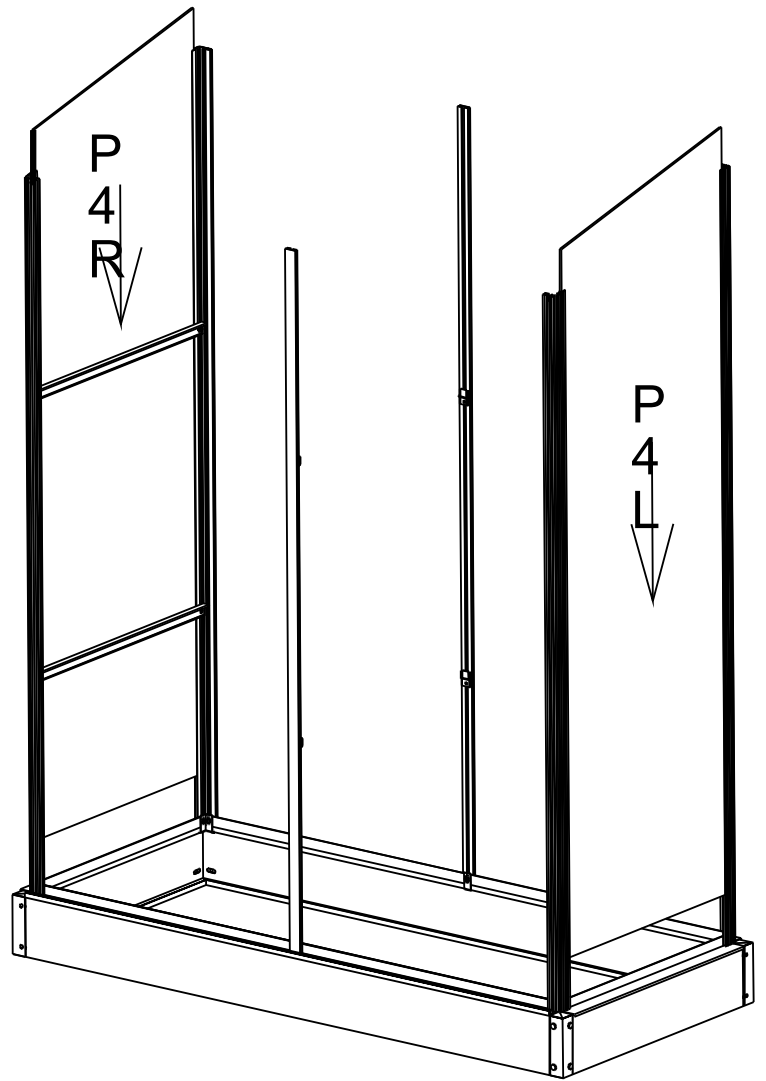

OSA	NRO	Määrä
	P4R	1
	P4L	1
	12R	1
	12L	1
	B5	4
	B2	2
	F4	8
	F6	2





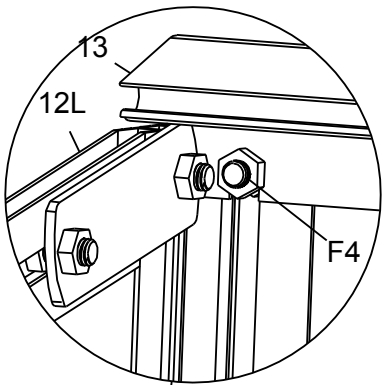
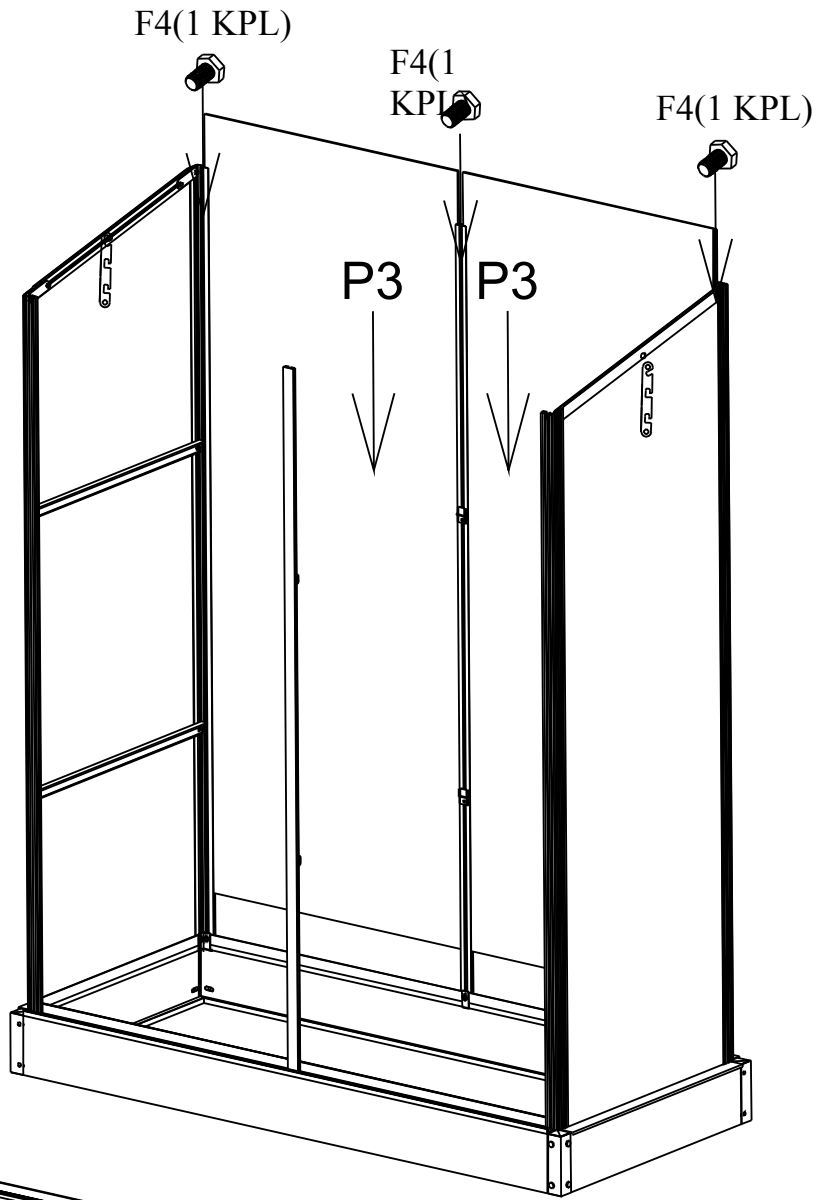

OSA	NRO	Määrä
	P3	2
	13	1
	F4	3

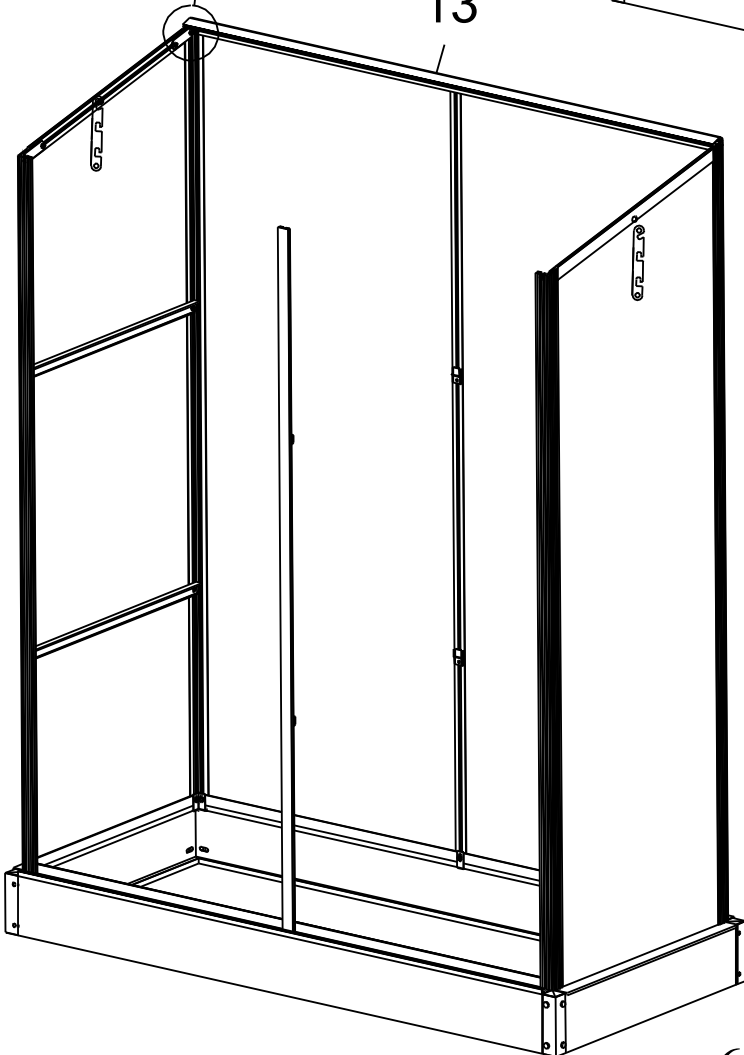

13



OSA	NRO	Määrä
	P5	1
	14	1
	B5	3
	F4	5
	F6	3

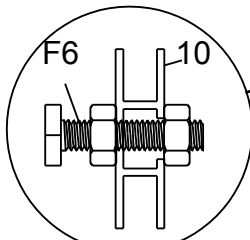
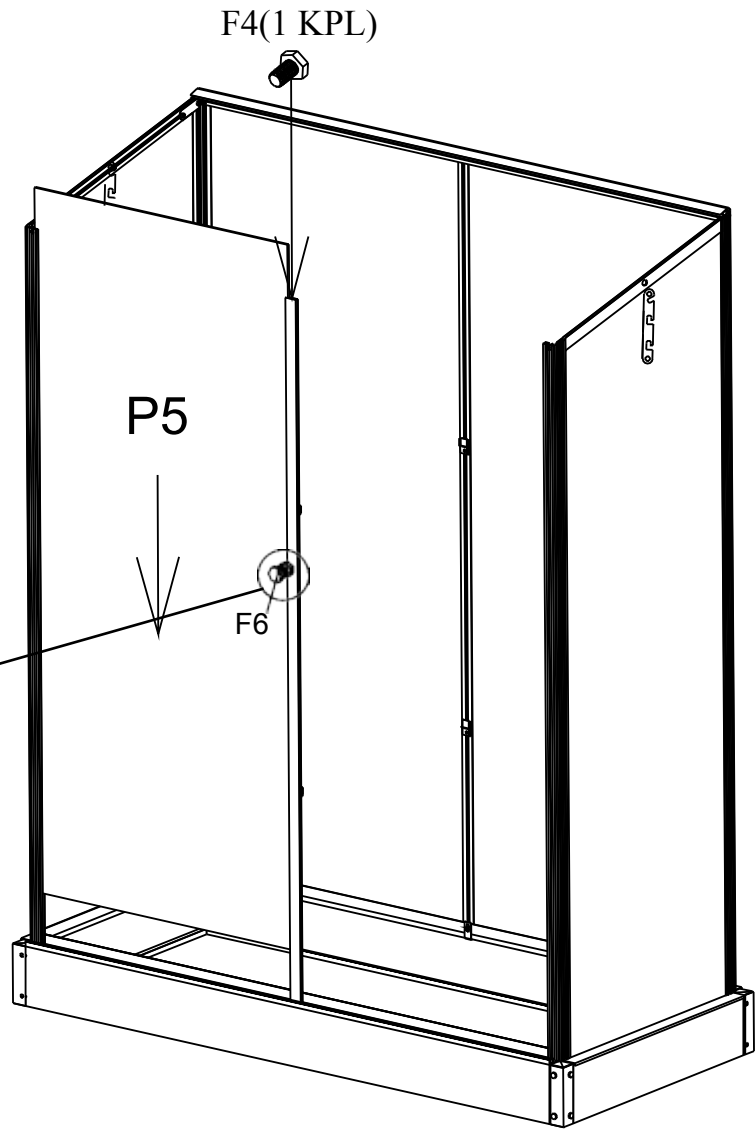



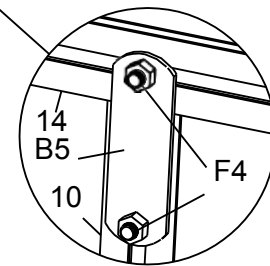
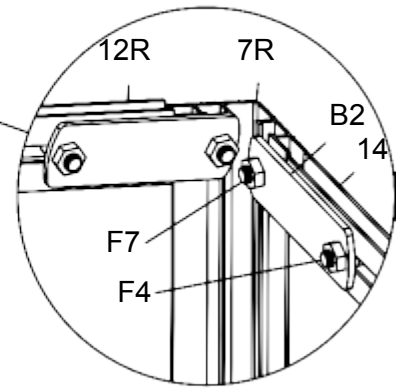
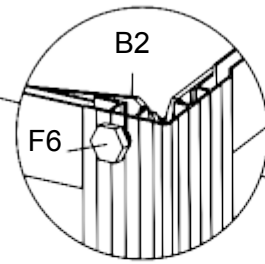
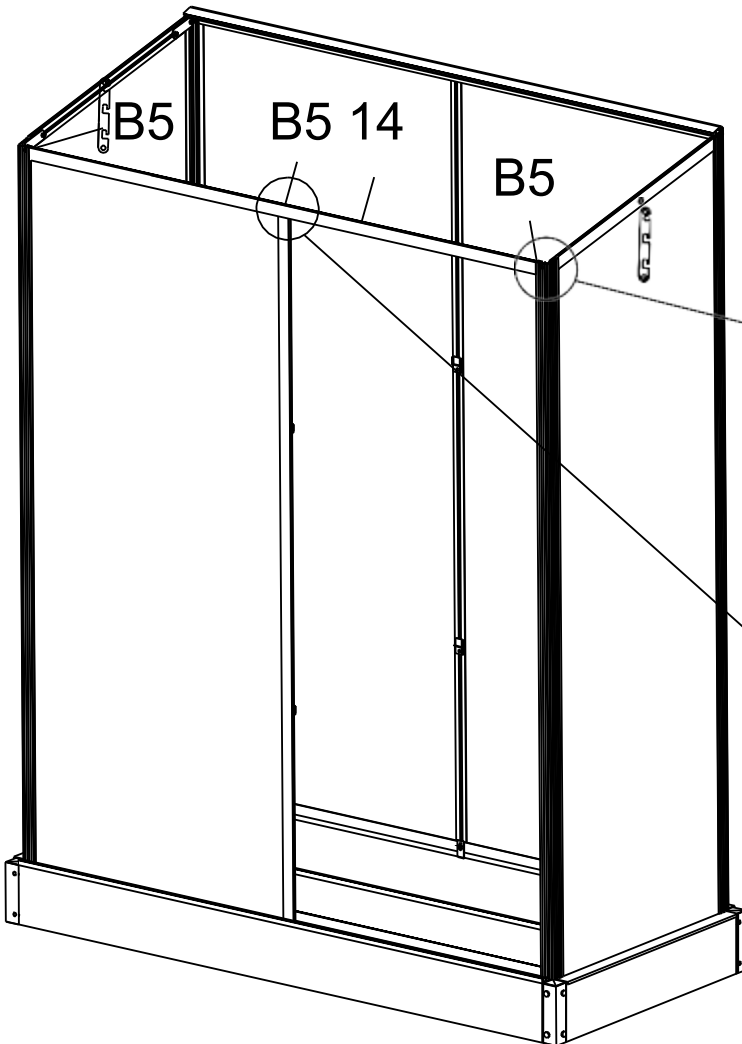

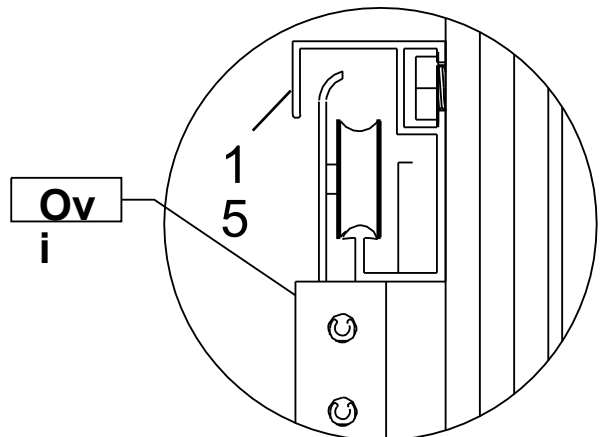
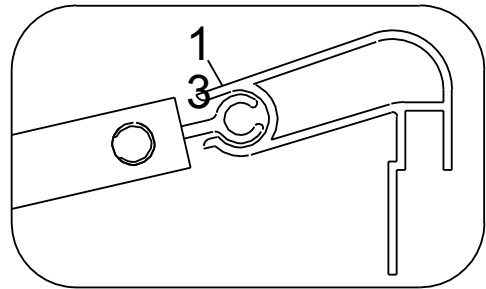
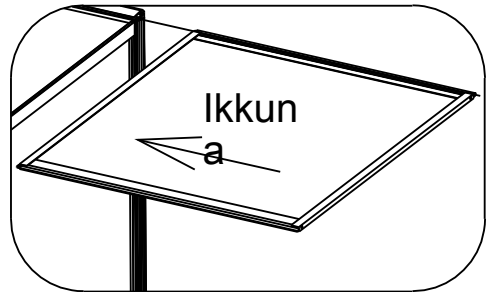
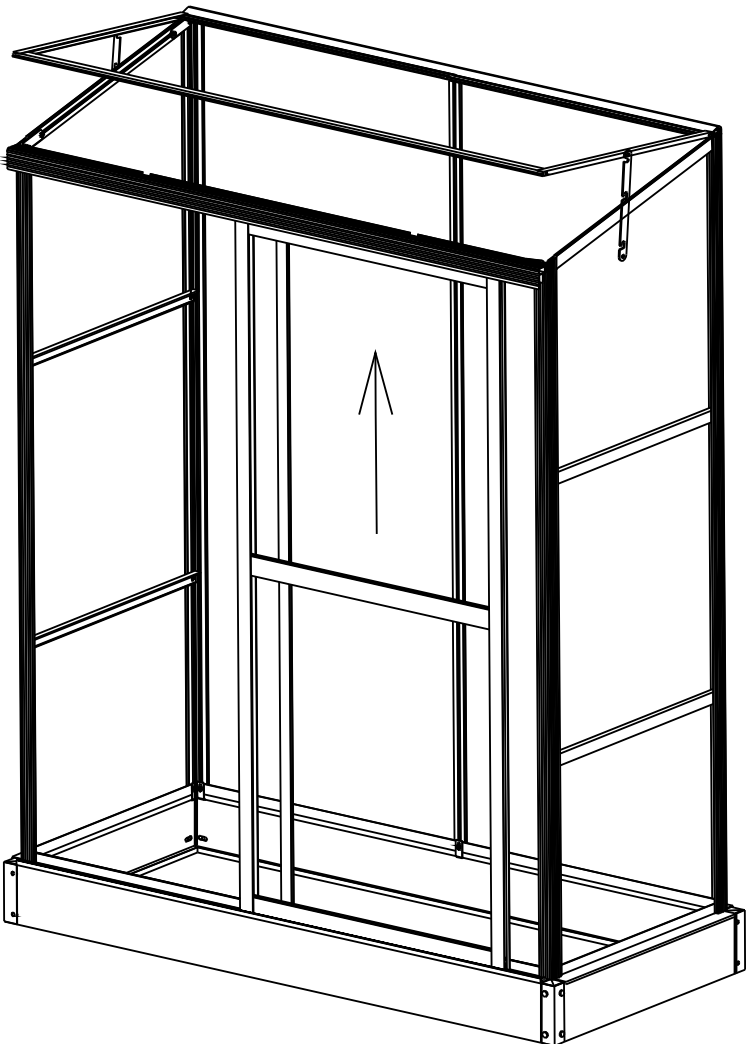
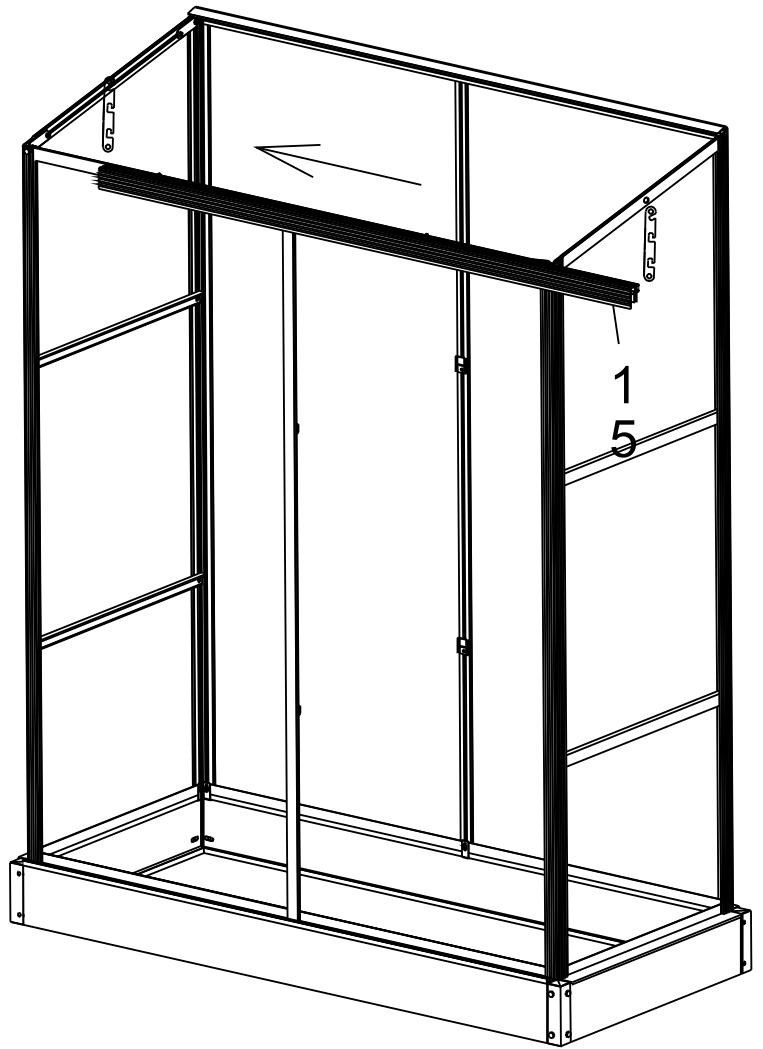
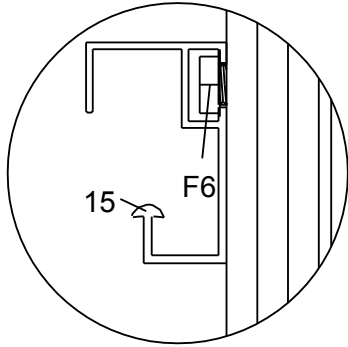

Oven rajoitin







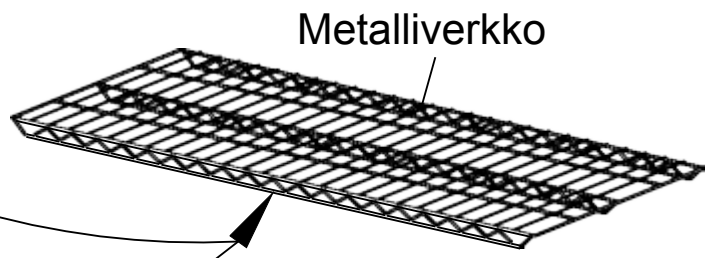
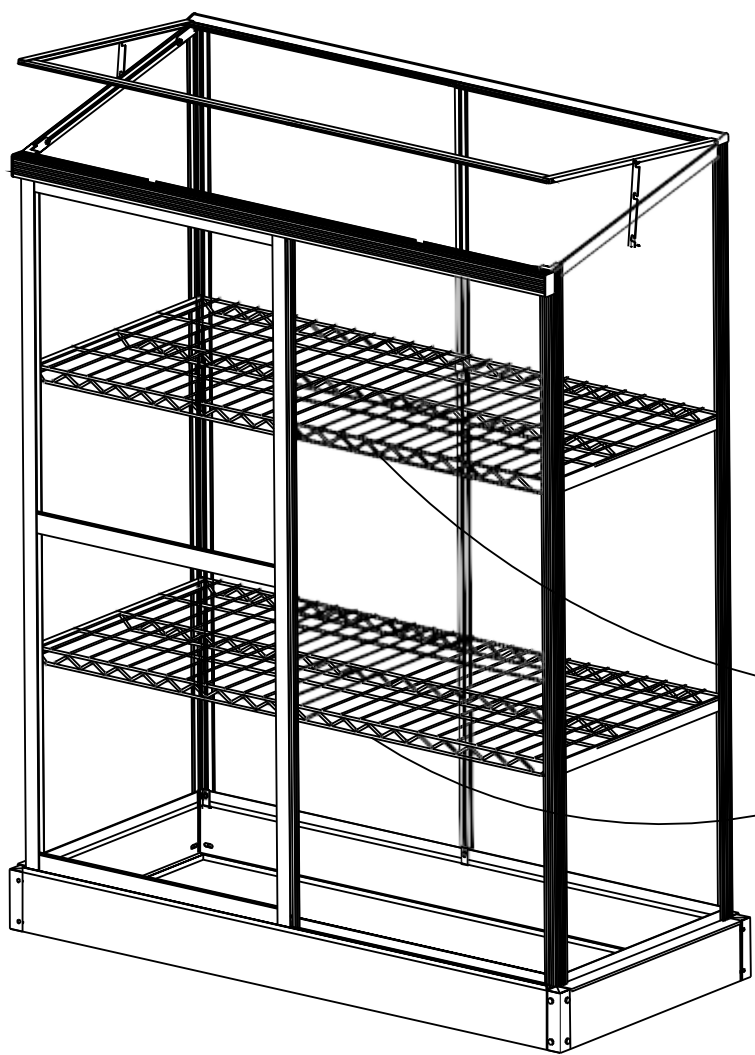
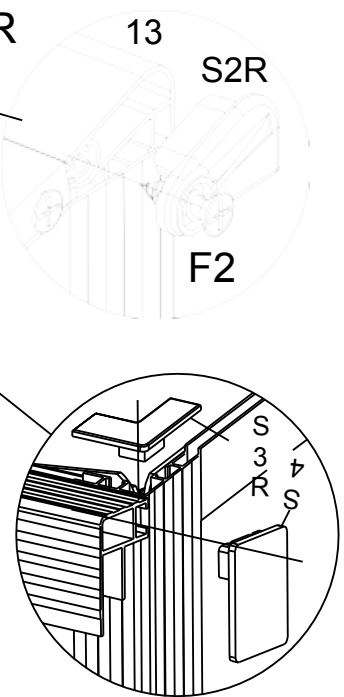
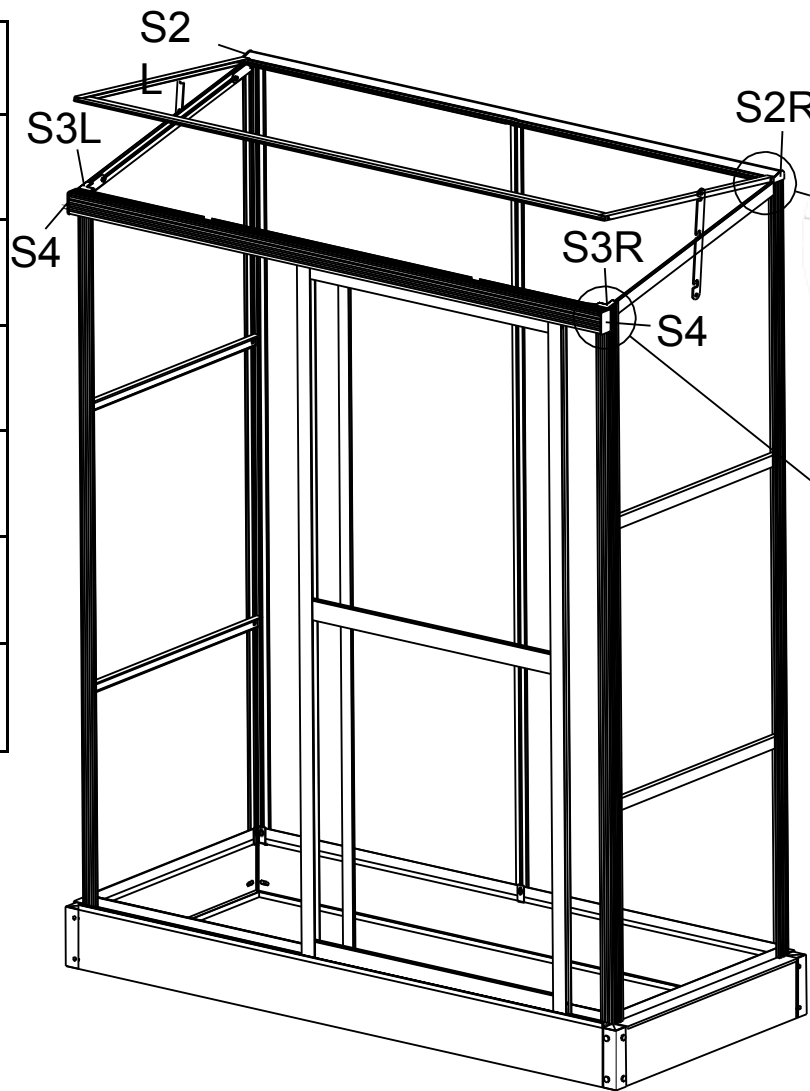

OSA	NRO	Määrä
	15	1



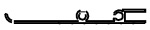

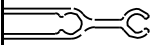
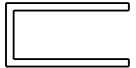
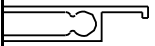
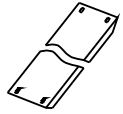

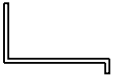

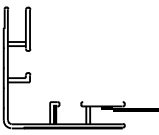
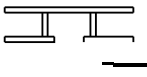



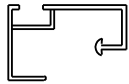
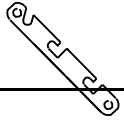

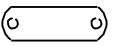
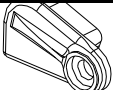
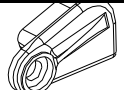
OSA	NRO	Määrä
	S2L	1
	S2R	1
	S3R	1
	S3L	1
	S4	2
	F2	2



OSALUETTELO SNGH-K

OSA	NRO	Määrä
	D1	1
	D4	1
	D2	1
	D3	2
	W1	1
	W2	2
	W3	1
	1	2
	2	2
	3	4
	4	2
	5	1
	6	1
	7R	1
	7L	1
	8	2
	9	1
	10	1
	12R	1
	12L	1
	14	1

OSA	NRO	Määrä
		
		
	11	4
	13	1
	15	1
	B1	2
	B3	10
	B4	4
	B5	7
	S2L	1
	S2R	1
	S3R	1
	S3L	1
	S4	2
	F1	8
	F2	8

OSA	NRO	Määrä
	F7	16
	F4	38
	F6	5

PC	P1	2
	P2	1
	P3	2
	P4R	1
	P4L	1
	P5	1

Växthusets monteringsinstruktioner

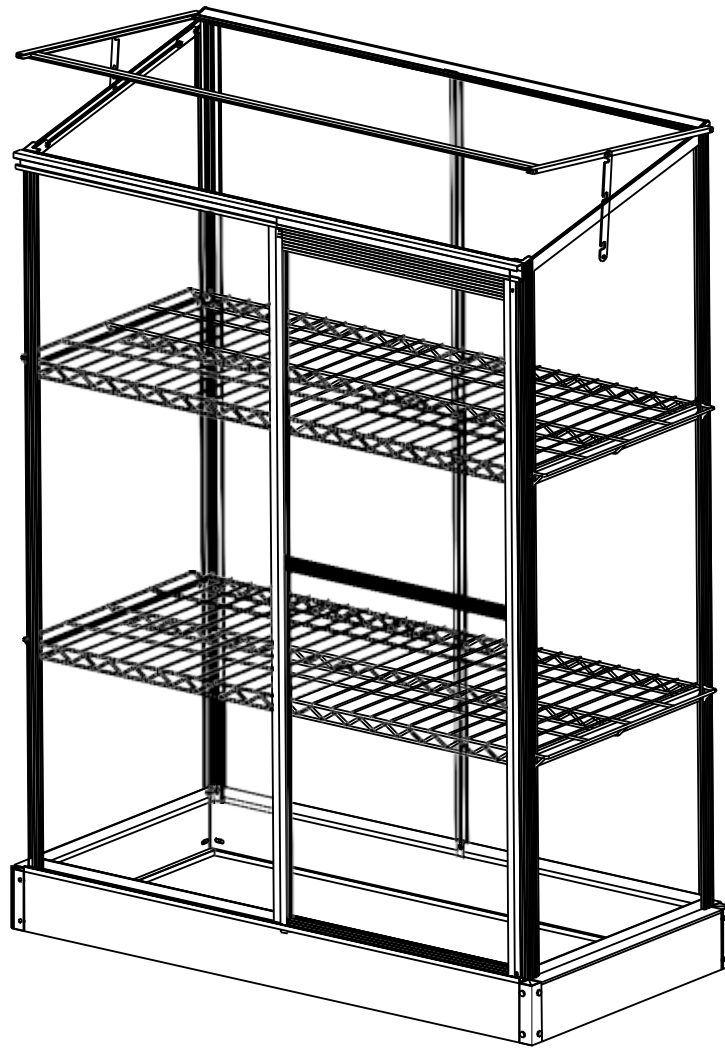

SNGH-K

VIKTIGT

Läs dessa instruktioner noggrant innan du börjar installationen av växthuset.

Se till att alla delar finns med och är lämpliga. Mängderna är listade och varje steg för monteringen är beskriven.

Följ monteringsanvisningarna noggrant. Dra inte åt delarna helt innan polykarbonatskivorna är färdigt installerade.

Spara instruktionerna.

SÄKERHET

Vi rekommenderar användningen av skyddshandskar under monteringen. Montera inte upp växthuset i en blåsig eller våt omgivning. Rör inte strömkablar med aluminiumprofilen.

Använd alltid skor och skyddsglasögon när du använder pressat aluminium.

Gör dig av med alla plastpåsar och håll dem borta från små barn. Växthuset bör placeras och fästas på en jämn yta.

Luta inte mot växthuset under bygget. Håll barnen på avstånd från monteringsområdet.

Placera inte växthuset på ett område där den utsätts för hårda vindar. Montera inte upp växthuset om du är trött, under påverka av mediciner eller alkohol, eller om du har benägenhet till yrselanfall.

Se till att följa säkerhetsanvisningarna om du använder dig av trappstege eller elverktyg.

Heta föremål, så som nyligen använda grillar, blåslampor osv. får inte förvaras i växthuset.

Kontrollera att det inte finns rör eller kablar i marken innan du placerar krokarna.

ALLMÄNNA INSTRUKTIONER

Monteringen består av flera olika faser. Monteringen tar minst en halv timme.

Välj en jämn och solig plats långt borta från hängande grenar. Använd de färdigt borrade hålen i metallunderlaget om du monterar upp växthuset direkt på ett stadigt betongfundament.

Delarna måste granskas och hållas nära till hands. Håll alla små delar (skruvar osv.) i ett kärl så de inte tappas bort.

Observera att dörrens gångjärn finns på högra sidan och öppnas därmed till höger. Håll taket rent från snö och löv.

UNDERHÅLL

Använd ett mildt tvättmedel då växthuset måste tvättas.

Använd inte aceton, slipmedel eller annat tvättmedel för att rengöra klara delarna.

VERKTYG OCH UTRUSTNING SOM KRÄVS



Silikon och silikonverktyg, hålverktyg, stjärnskruvmejsel, stegar.

Måttband, stor hammare, saxar.



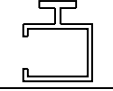
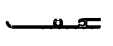
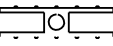

Arbetshandskar, borr, vattenpass, smörjningsmedel, plast- eller gummiklubba, 2 mm borr.

Om du behöver hjälp, be någon professionell hjälpa dig.

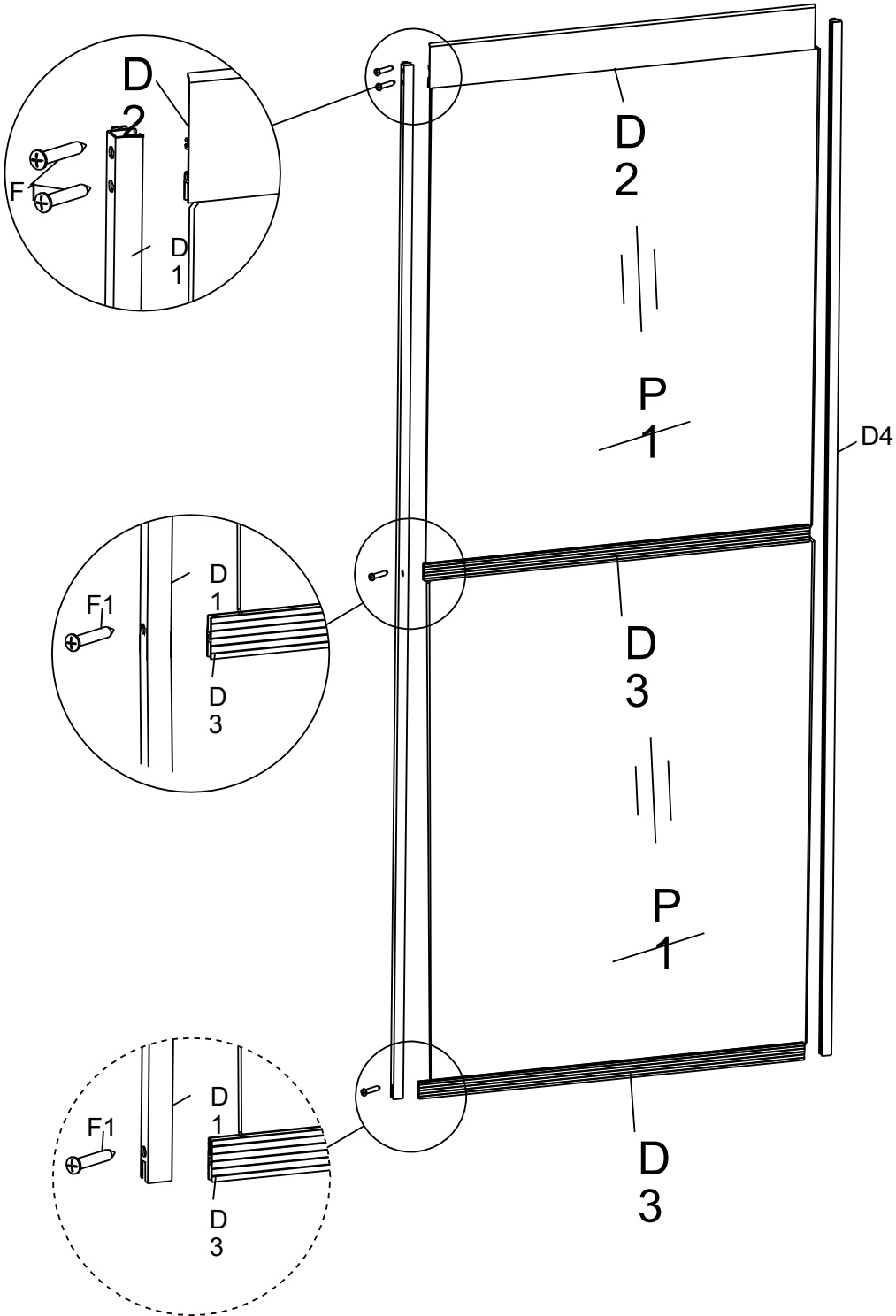
DÖRR

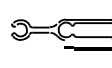
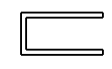
DEL	N R	Mä ng d
	D	1
	∅	1
	4 D	1
	2	2
	F 1	8

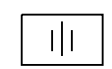

DEL	NR	Mängd
	W1	1
	W2	2
	W3	1
	P2	1
	F2	6

FÖNSTE R

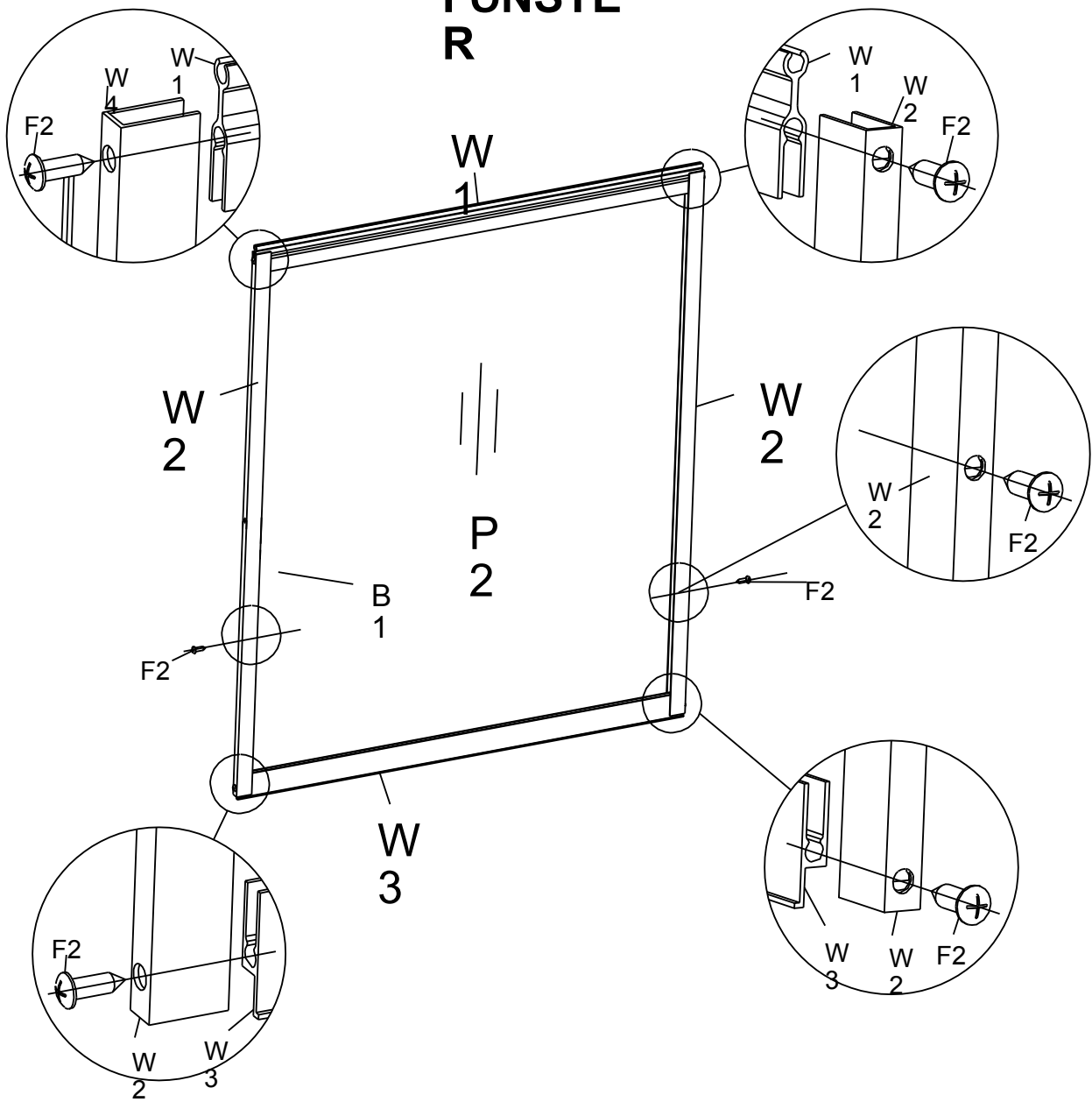

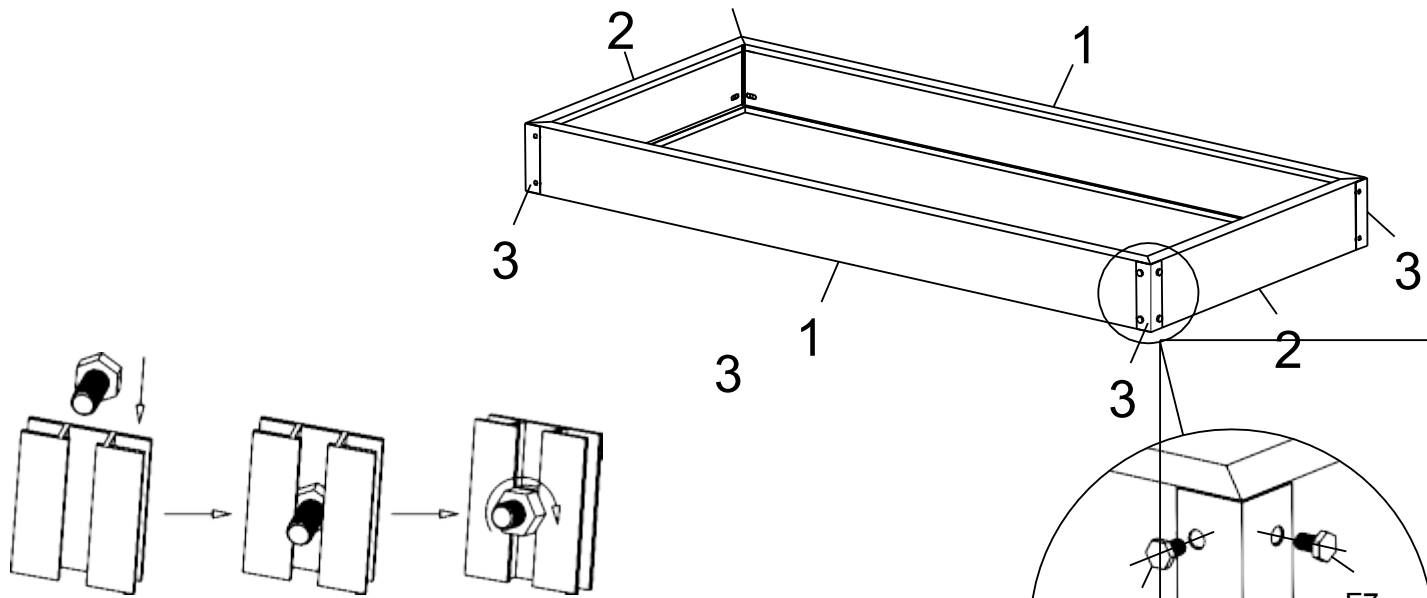





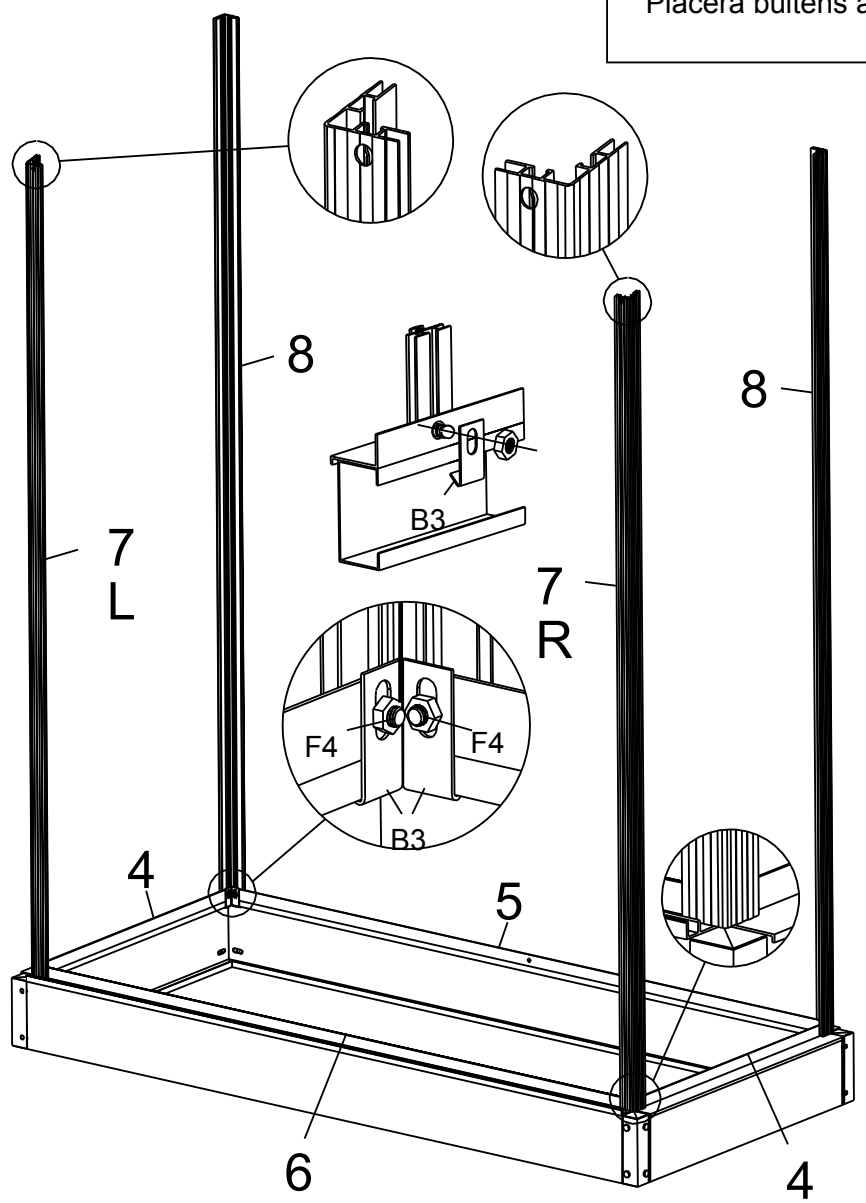

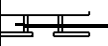
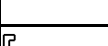
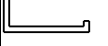

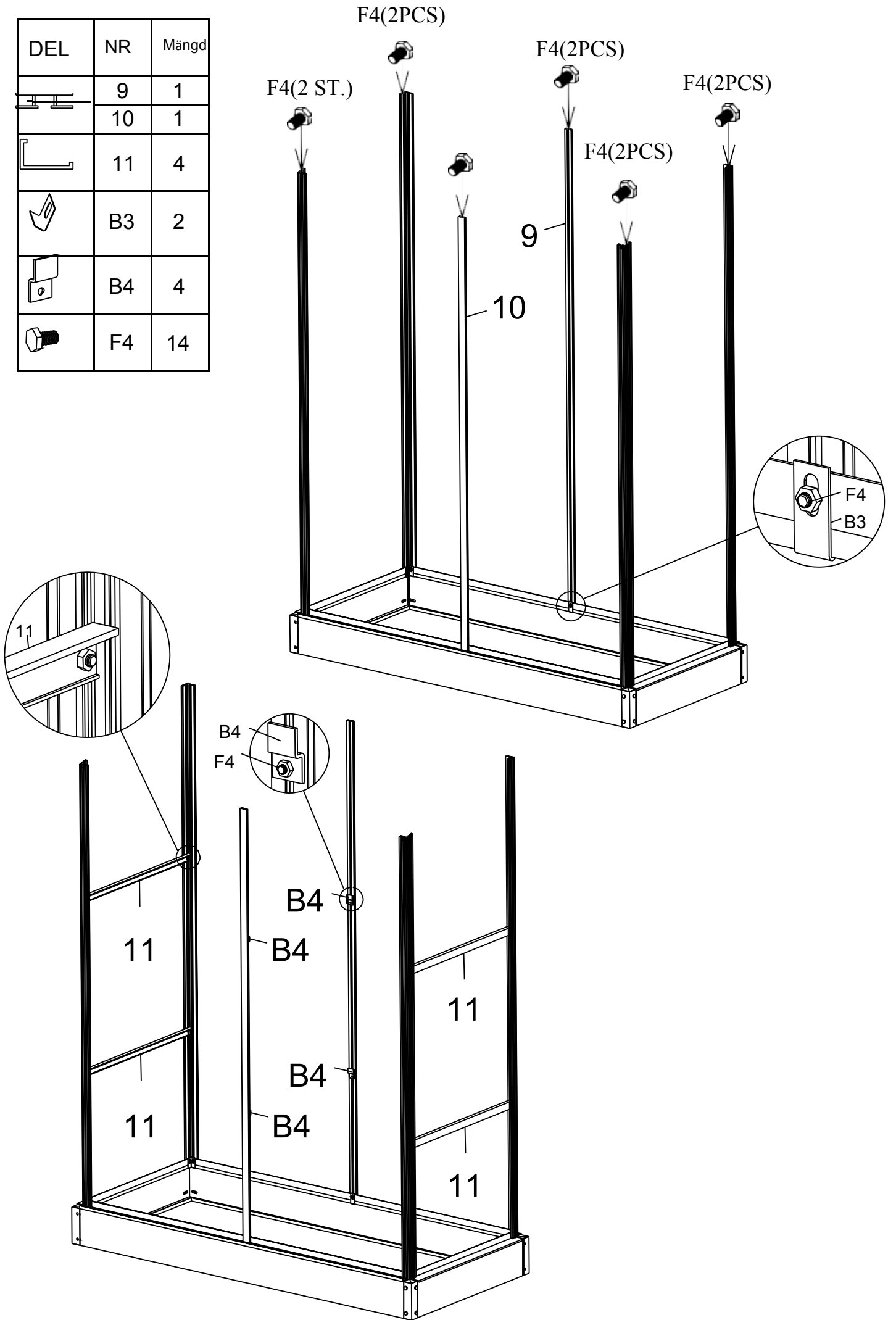

Installation av
 Placera bulten i gån
 medsols tills den int
 Justera bulten så att
 den på plats.
 Placera bultens and

DEL	NR	Mängd
	1	2
	2	2
	3	4
	4	2
	5	1
	6	1
	7R	1
	7L	1
	8	2
	B3	8
	F7	16
	F4	8

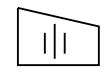
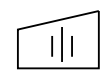

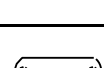
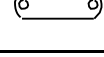

DEL	NR	Mängd
	9	1
	10	1
	11	4
	B3	2
	B4	4
	F4	14

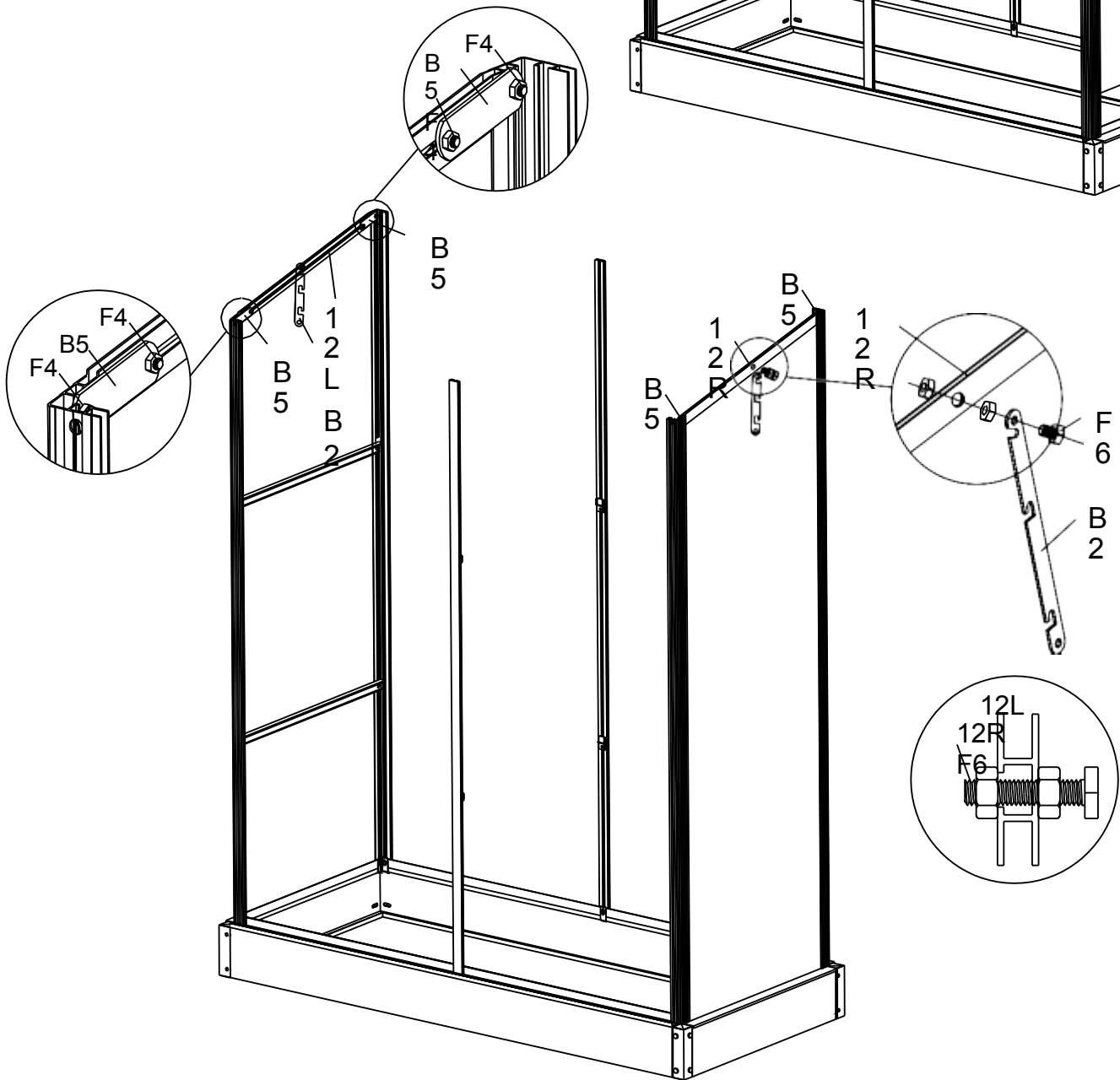
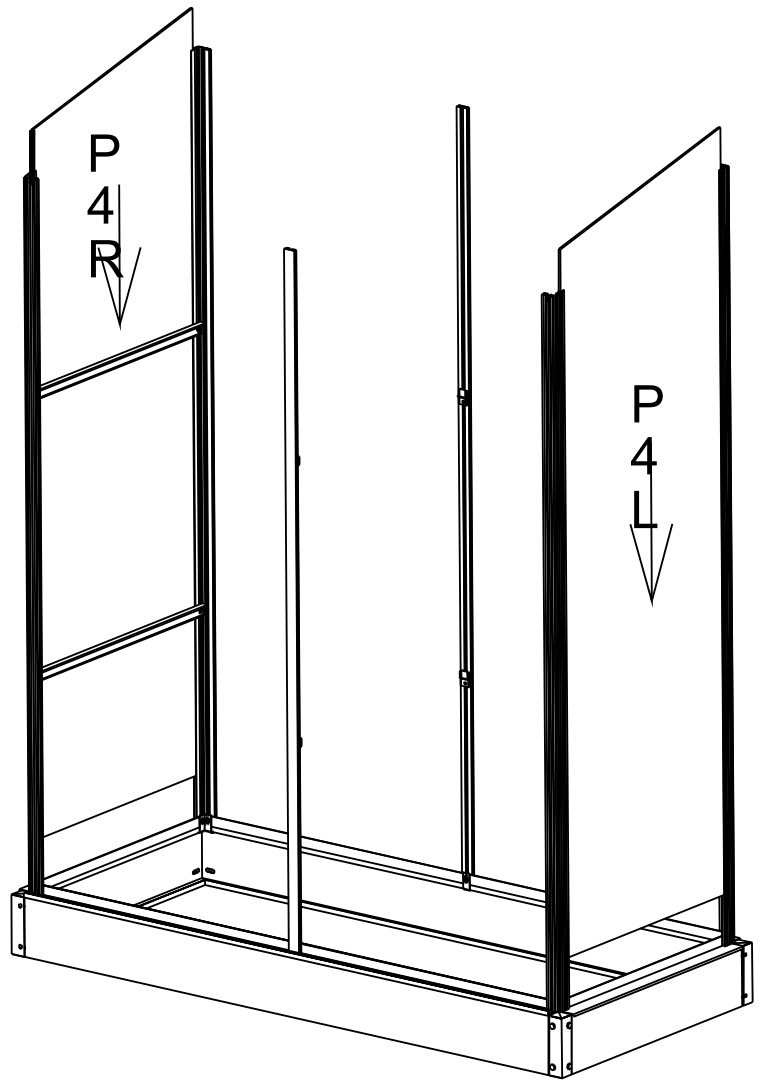

DEL	NR	Mängd
	P4R	1
	P4L	1
	12R	1
	12L	1
	B5	4
	B2	2
	F4	8
	F6	2





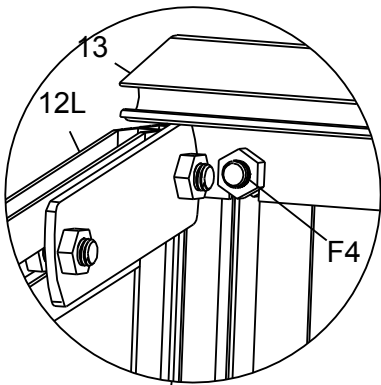
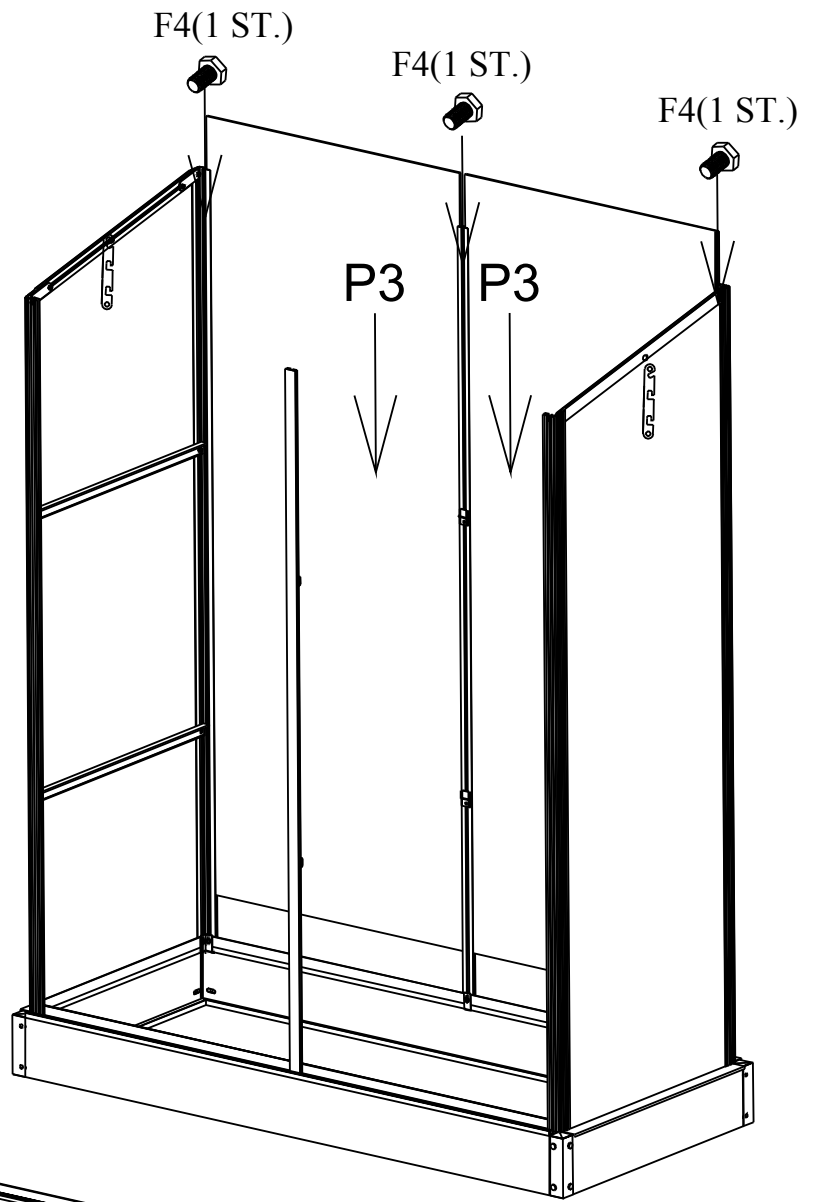

DEL	NR	Mängd
	P3	2
	13	1
	F4	3

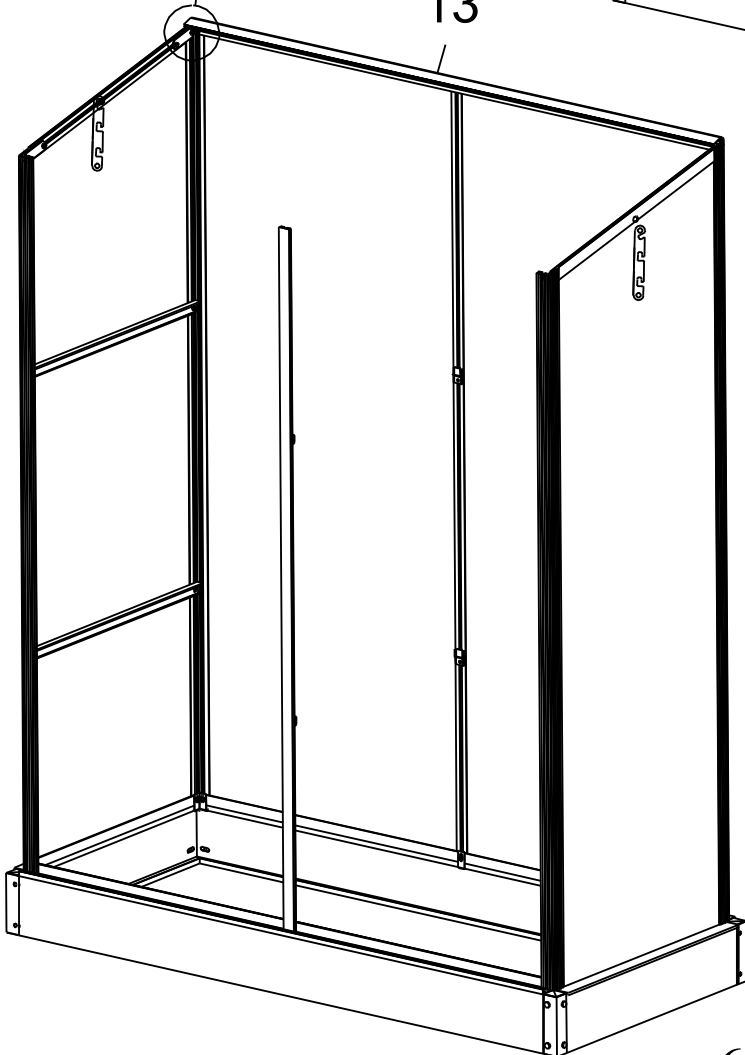

13

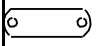



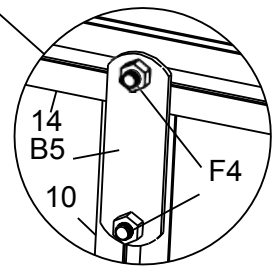
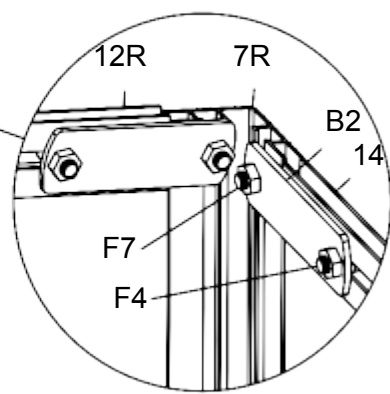
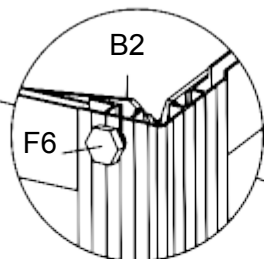
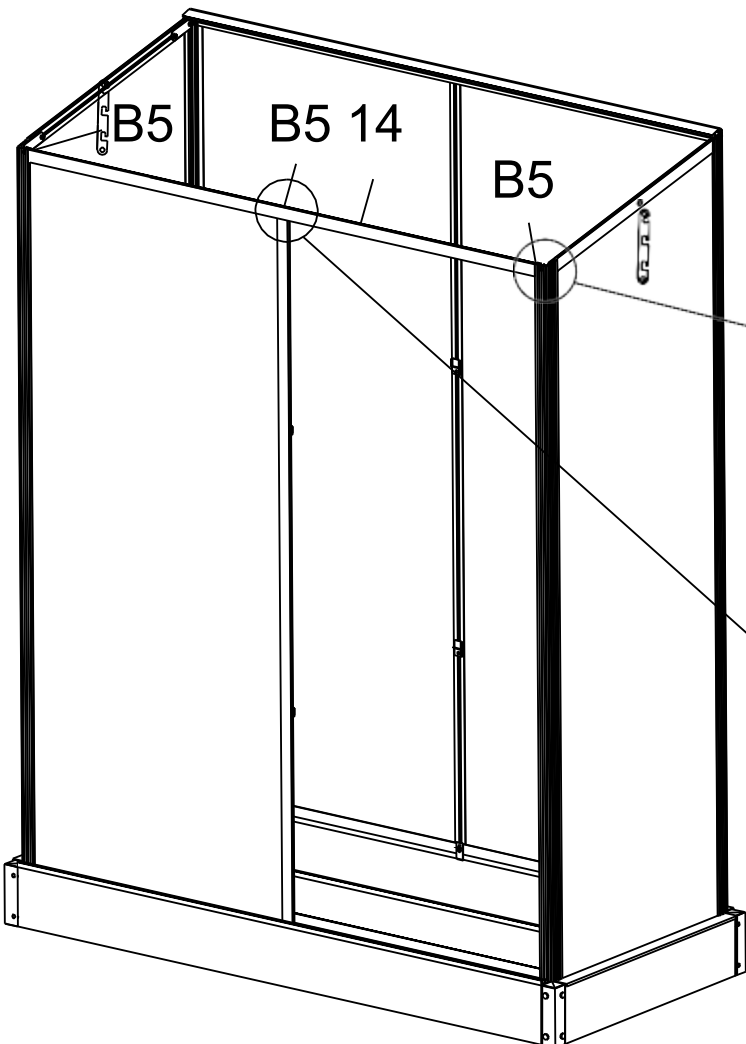
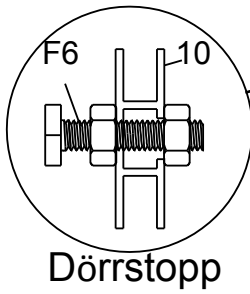
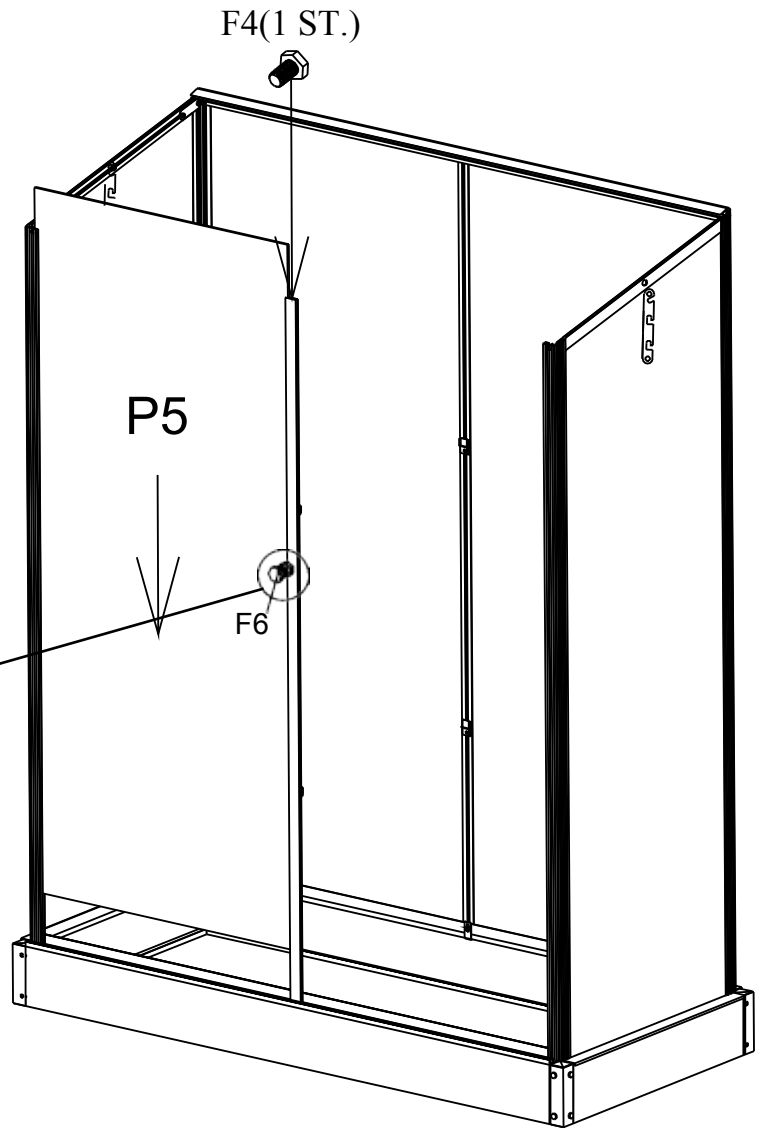

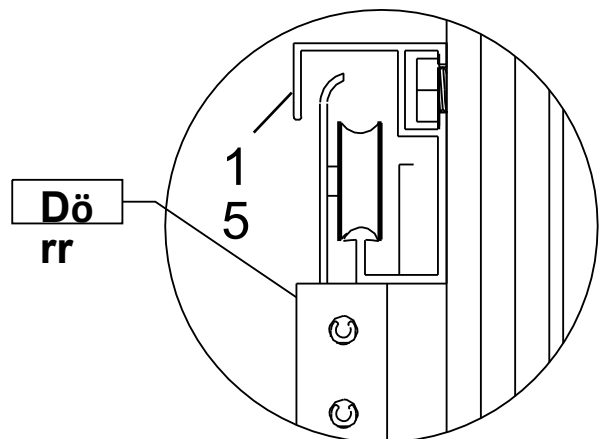
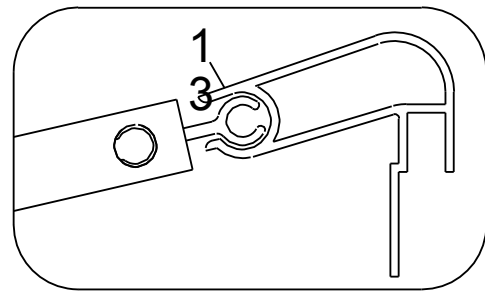
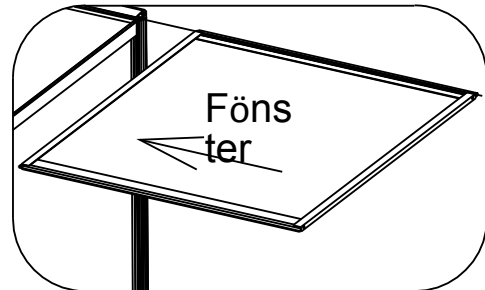
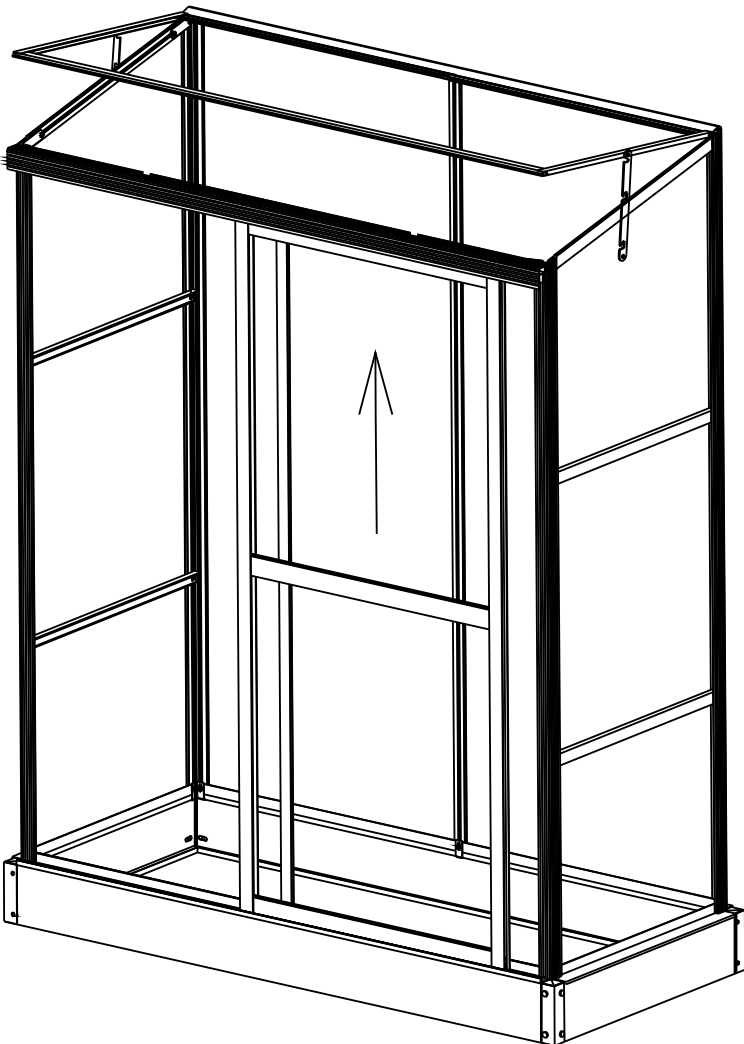
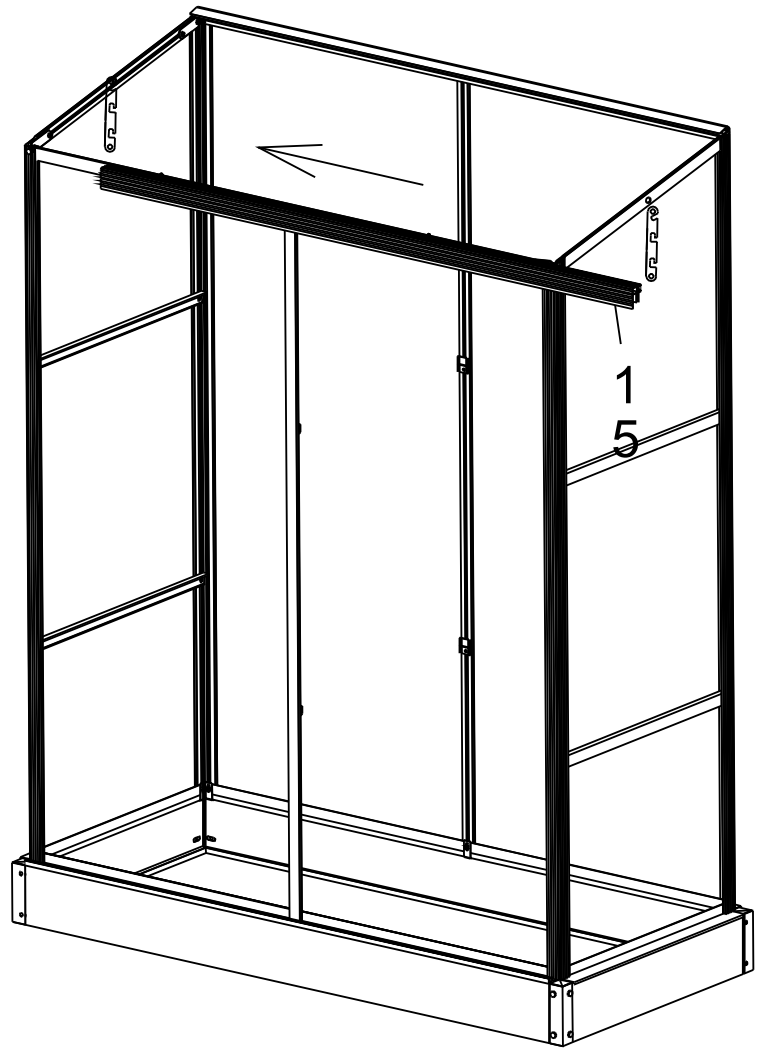
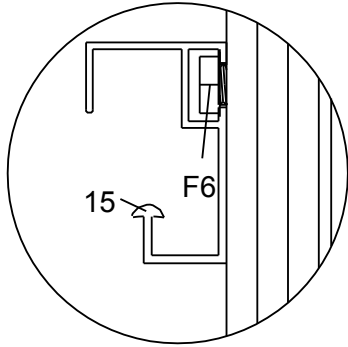

DEL	NR	Mängd
	P5	1
	14	1
	B5	3
	F4	5
	F6	3







DEL	NR	Mängd
	15	1

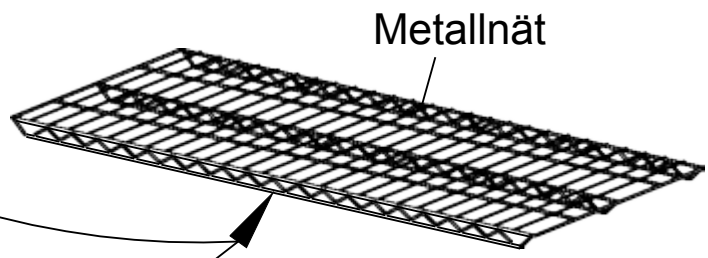
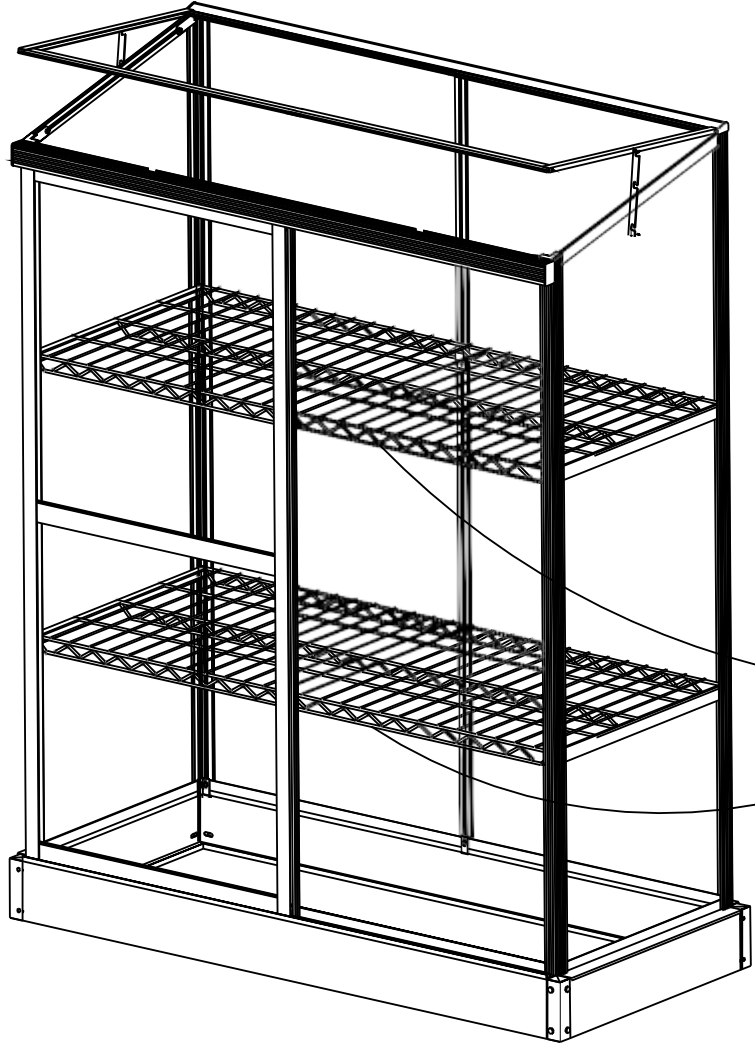
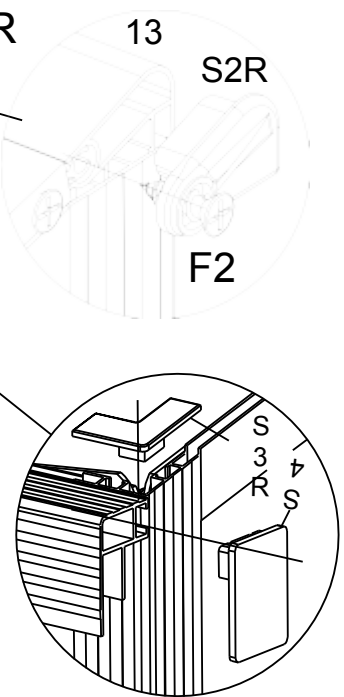
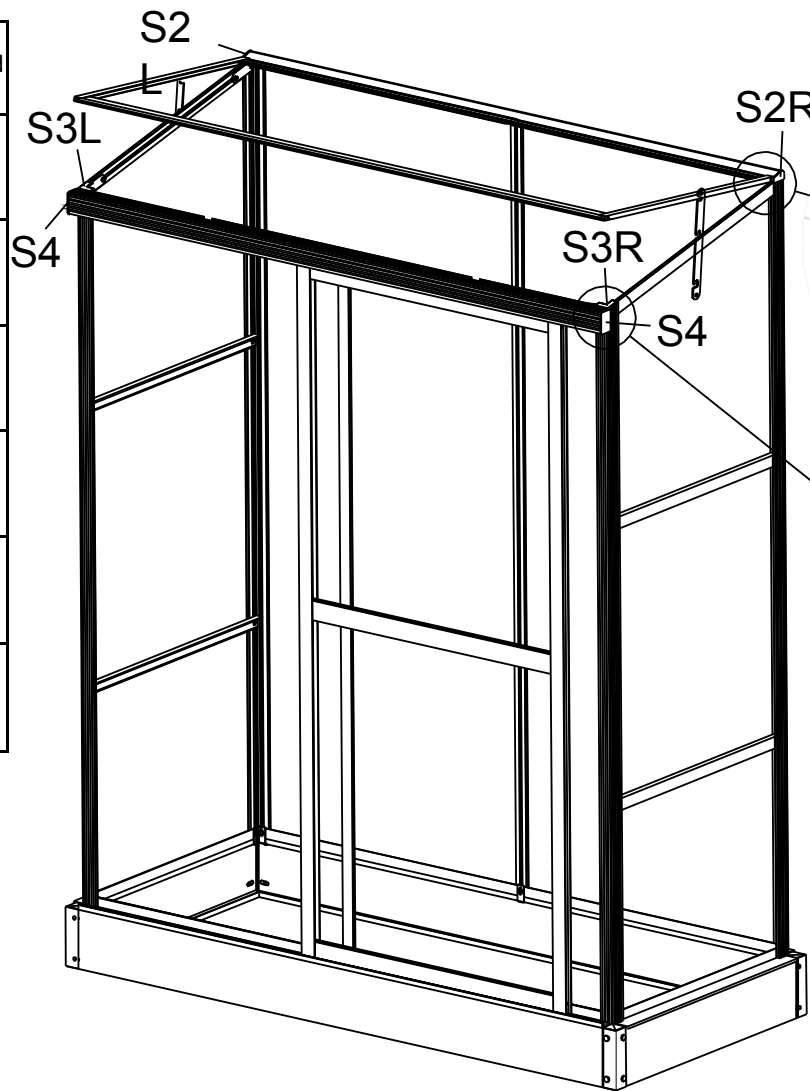



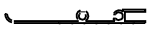

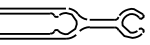
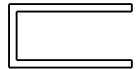
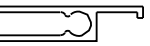
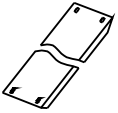
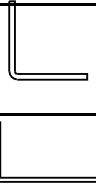

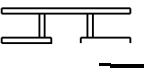

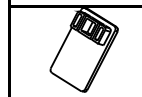
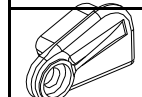
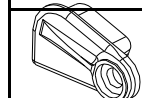
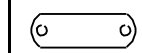
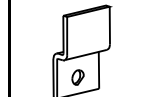
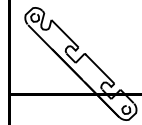
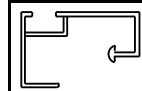
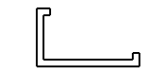
DEL	NR	Mängd
	S2L	1
	S2R	1
	S3R	1
	S3L	1
	S4	2
	F2	2

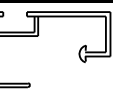
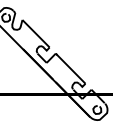

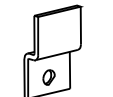
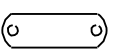
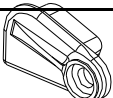
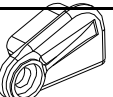

DELLISTA SNGH-K

DEL	NR	Mängd
	D1	1
	D4	1
	D2	1
	D3	2
	W1	1
	W2	2
	W3	1
	1	2
	2	2
	3	4
	4	2
	5	1
	6	1
	7R	1
	7L	1
	8	2
	9	1
	10	1
	12R	1
	12L	1
	14	1

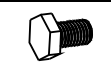

DEL	NR	Mängd
	11	4
	13	1
	15	1
	B1	2
	B3	10
	B4	4
	B5	7
	S2L	1
	S2R	1
	S3R	1
	S3L	1
	S4	2
	F1	8
	F2	8

DEL	NR	Mängd
	F7	16
	F4	38
	F6	5

PC	P1	2
	P2	1
	P3	2
	P4R	1
	P4L	1
	P5	1