

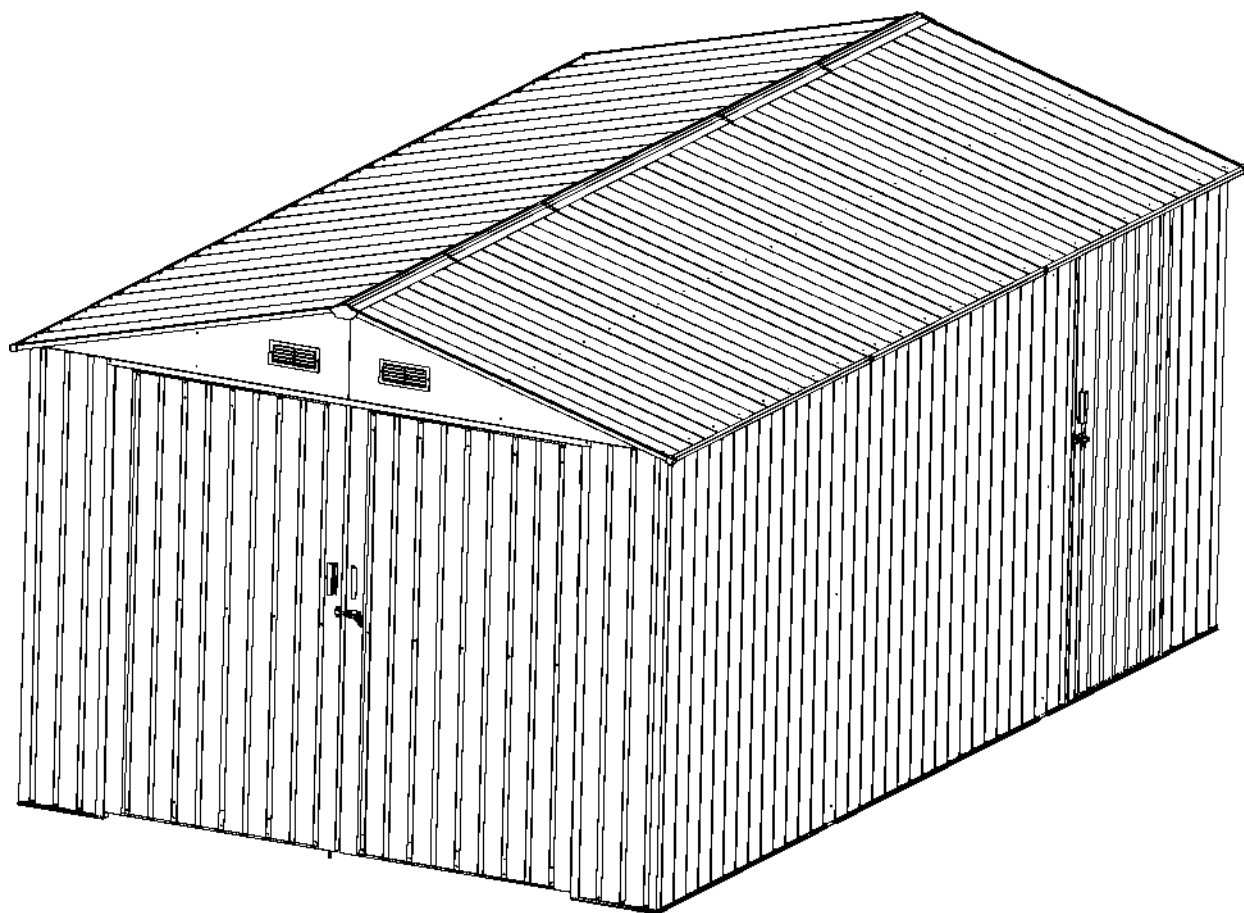





























































































**VILLAHOUSE C1**  
**HARMAA AUTOTALLI /**  
**VARASTO**  
**ASENNUSOPAS**



# OSALUETTELO

	1	2
	2	2
	3	2
	3L	1
	3R	1
	4L	1
	4R	1
	5L	1
	5R	1
	6L	1
	6R	1
	7	1
	8	2
	9	2
	10L	1
	10R	1
	11	2
	12L	1
	12R	2
	12	4
	13	4
	14	4
	15	6
	16	2
	17	2
	7L	1
	7R	1
	18	2
	19	7

	21L	2
	21R	2
	22	2
	23	1
	24	2
	25L	1
	25R	1
	35	1
	31	4
	32	4
	33	4
	34	2
	B1	2
	B2	2
	B3	4
	J4	2
	L1	16
	P1	9
	P2	2
	P3	2
	P4	1
	P5	1
	P6	1
	P7	1
	P6L	1
	P6R	1
	P4L	8
	P4R	6
	F5	100
	GC	4
	GE	2
	GF	4

	D1	2
	D2	1
	30	4
	29	4
	29-1	4
	36	1
	37	1
	38	1
	39	1
	40	1
	41	1
	42	2
	43	4
	44	1
	45	1
	46	1
	47	1
	48	2
	49	2
	50	2
	J1	4
	J2	4
	J3	2
	B5	3
	B6	9
	H1	2
	H2	2
	J5	1
	J6	1
	F1	880
	F2	200
	F3	40
	F4	17

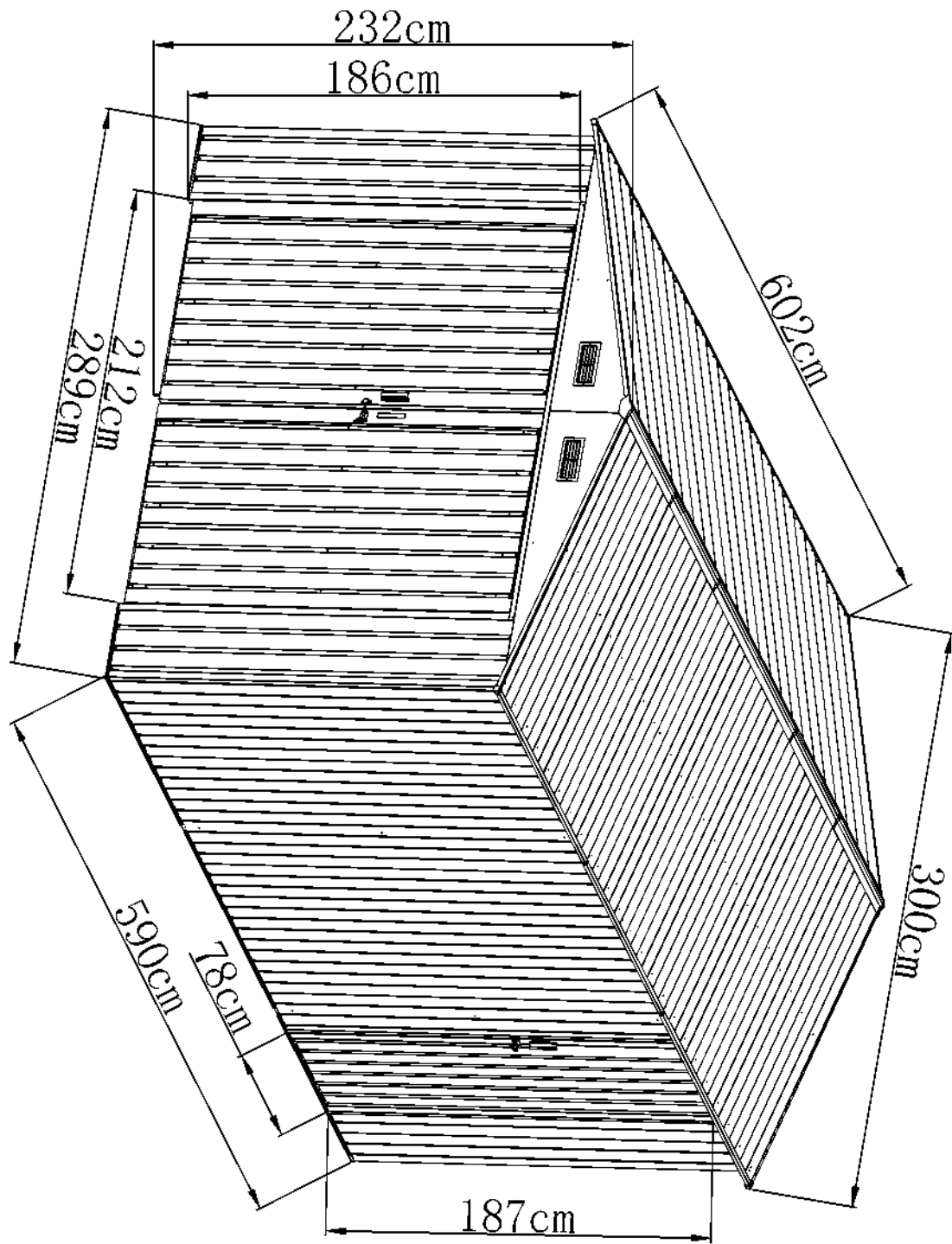

MITAT

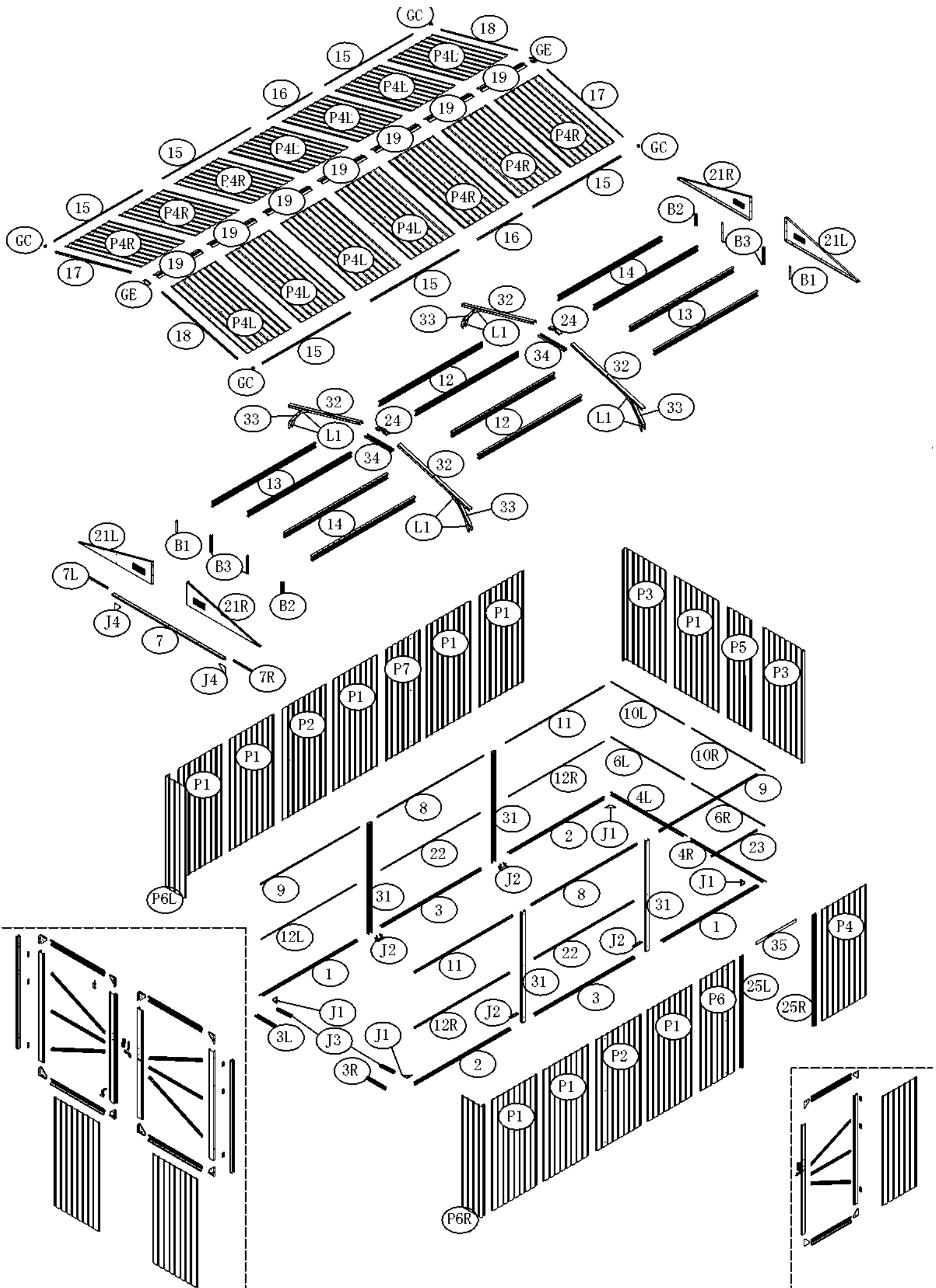

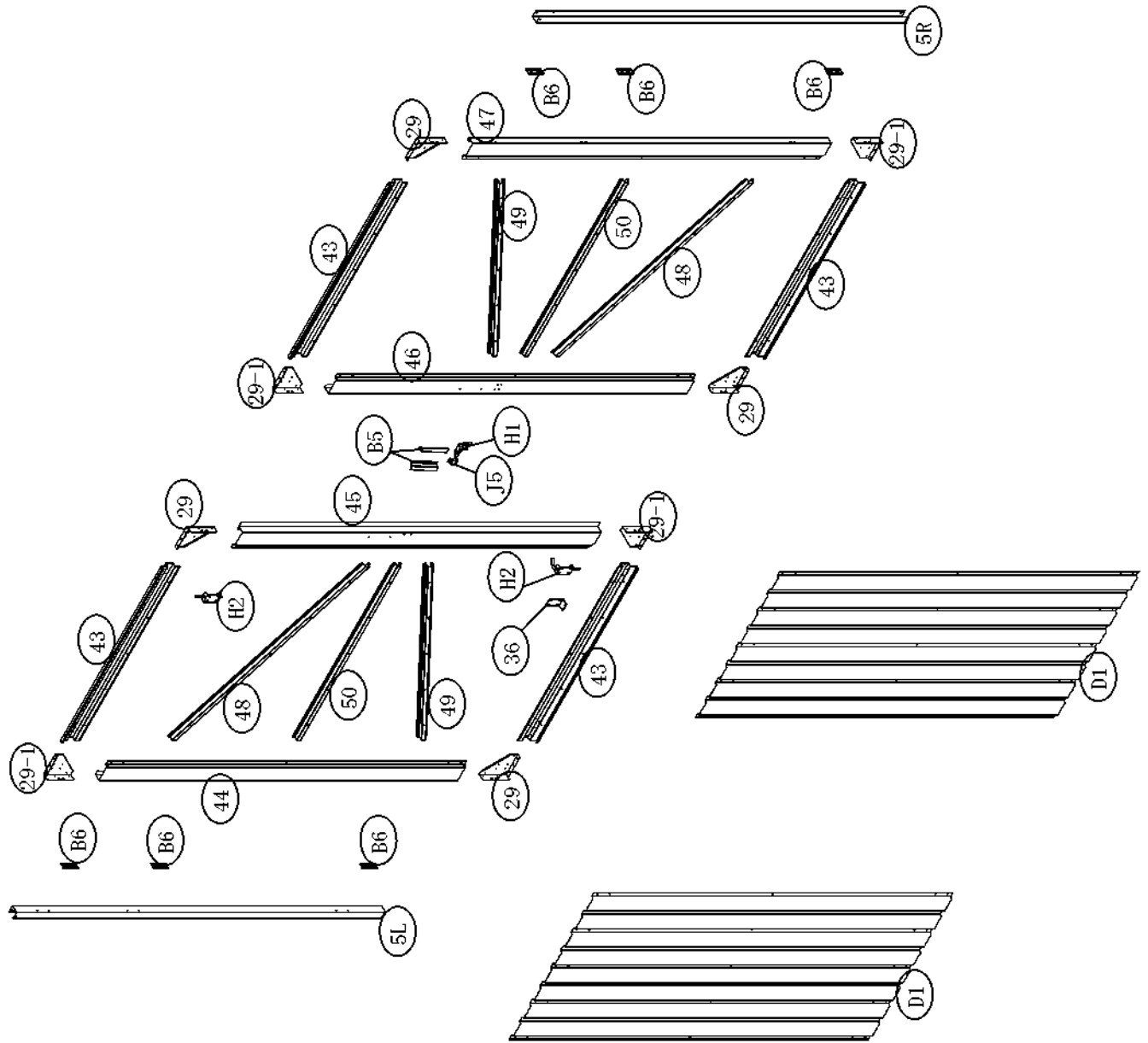
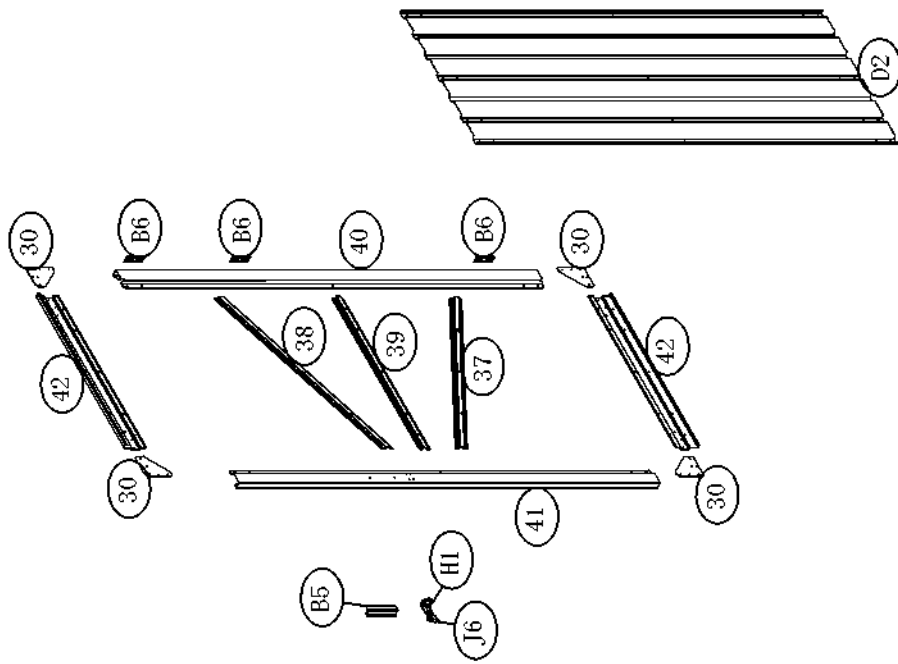

# RUNGON KOKOAMINEN

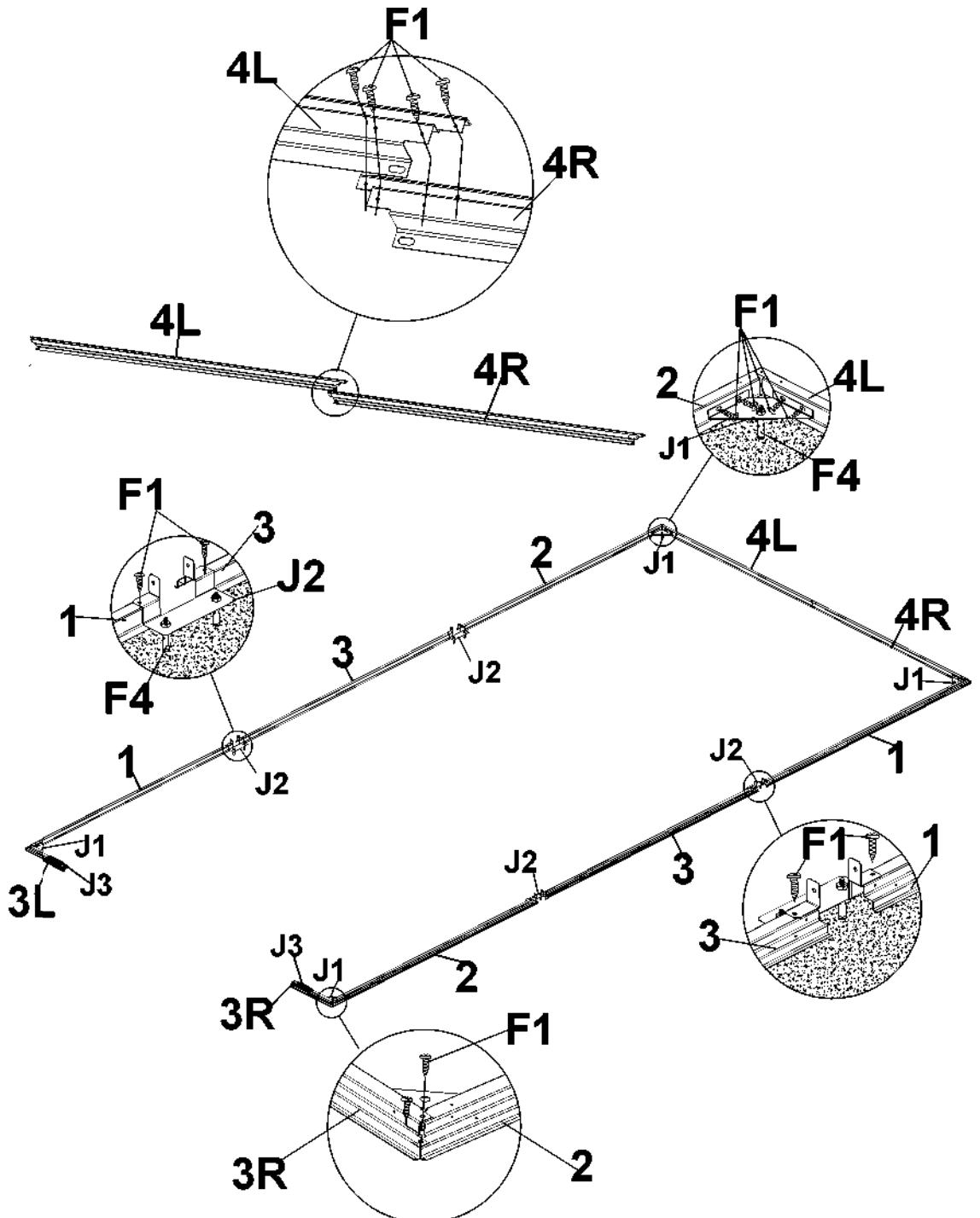

	1	2
	2	2
	3L	1
	3R	1
	4L	1
	4R	1
	3	2
	J1	4
	J2	4
	J3	2
	F1	
	F4	

Varo teräviä reunoja. Käytä suojakäsineitä.

Ota esille kuvassa näkyvät osat ja kiinnitä ne ruuveilla (F1).

Varmista, että runko kootaan täydelliseen neliöön.

\* Varmista, että tukipalkit kootaan täydelliseen neliöön.

\* Rungossa on ylimääräisiä reikiä. Niiden avulla talli voidaan kiinnittää puu- tai betoniperustaan.

Vielä paremman kiinnityksen saat käyttämällä ankkurointisarjojamme.



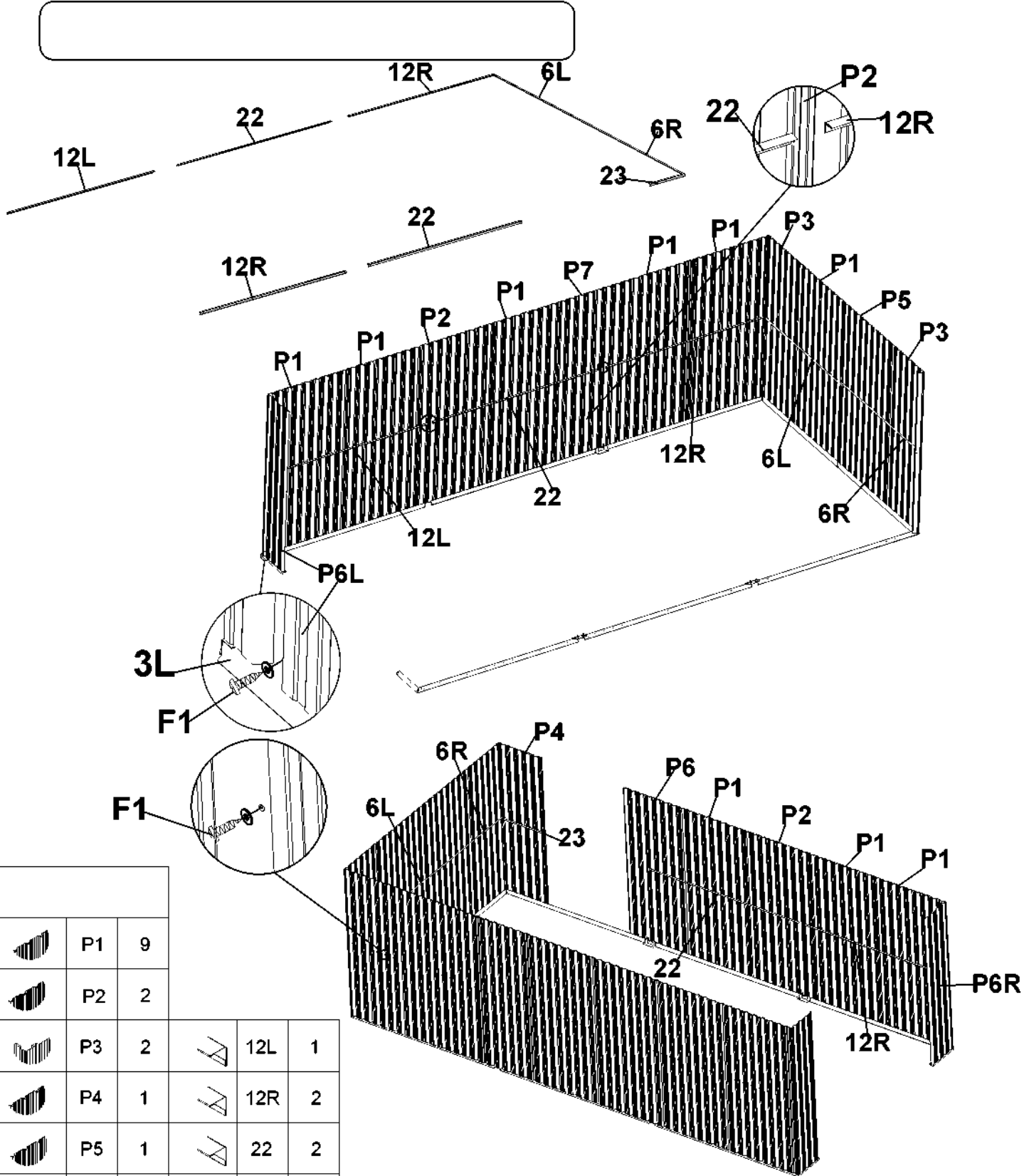



# SIVUSEINÄN KOKOAMINEN

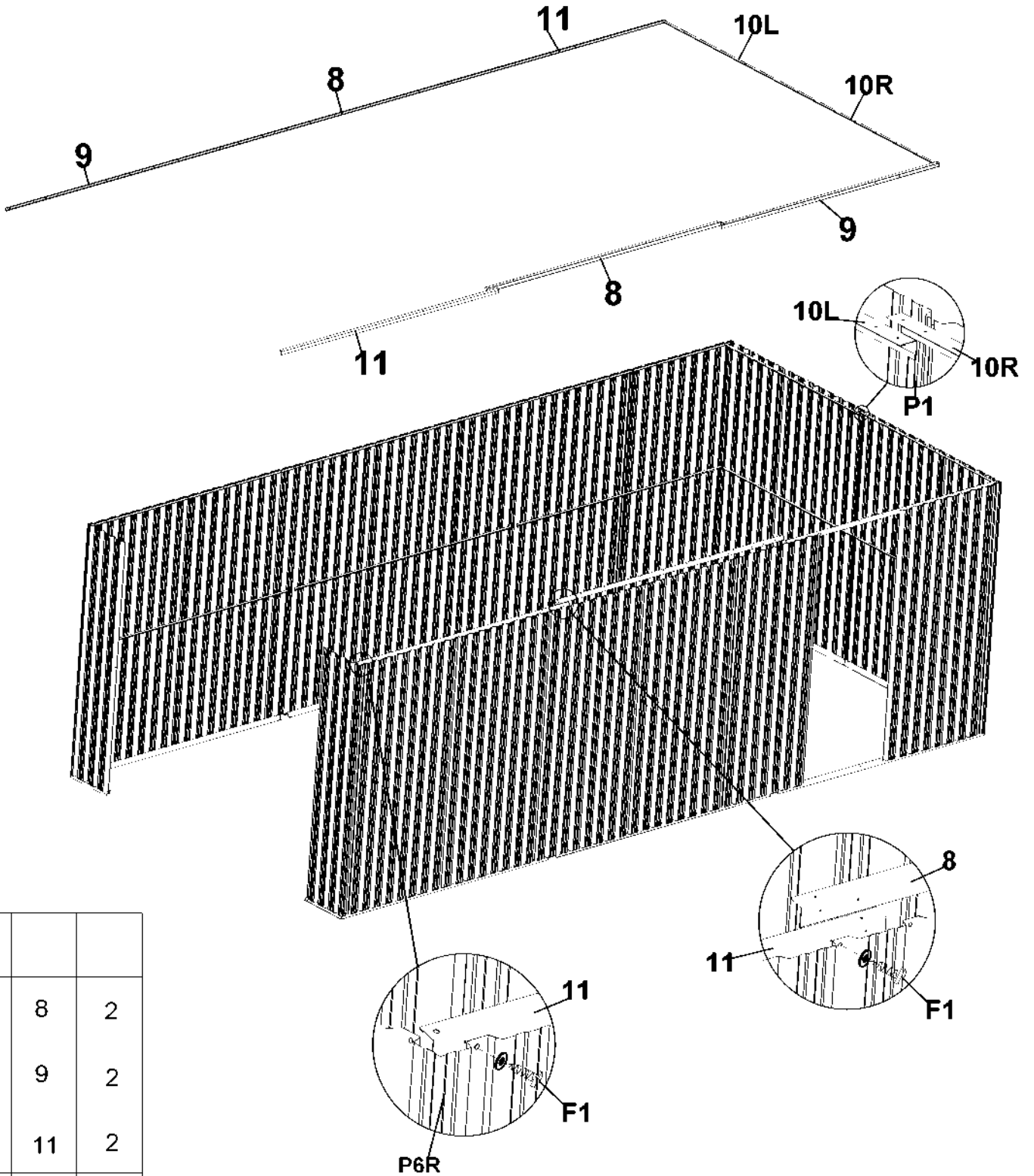

	P1	9			
	P2	2			
	P3	2		12L	1
	P4	1		12R	2
	P5	1		22	2
	P6	1		23	1
	P7	1		6L	1
	P6L	1		6R	1
	P6R	1		F1	







# YLÄRUNGON ASENNUS

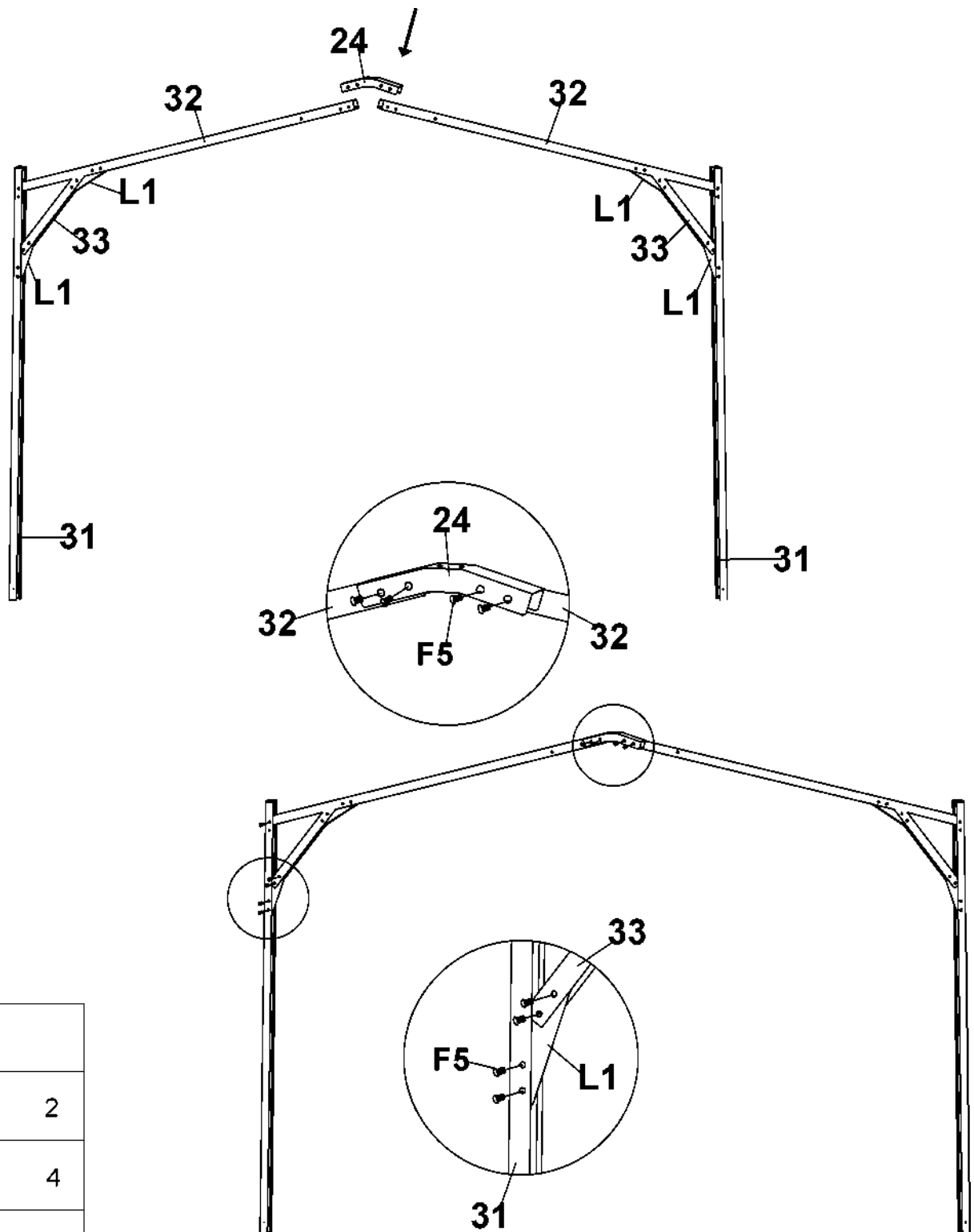

	8	2
	9	2
	11	2
	10L	1
	10R	1
	F1	

# TUKIRAKENTEEN KOKOAMINEN 1



	24	2
	31	4
	32	4
	33	4
	L1	16
	F5	

# TUKIRAKENTEEN KOKOAMINEN 2

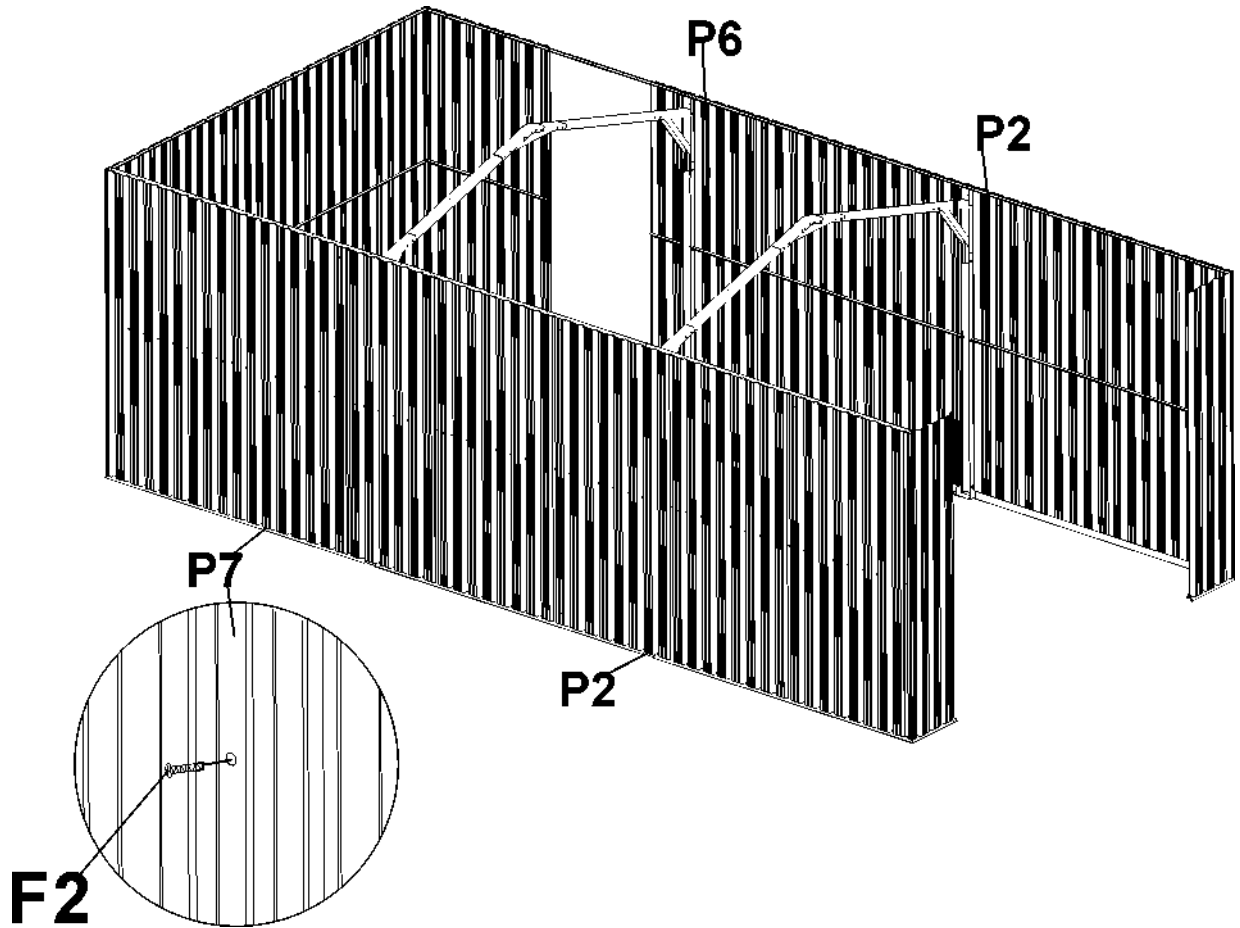







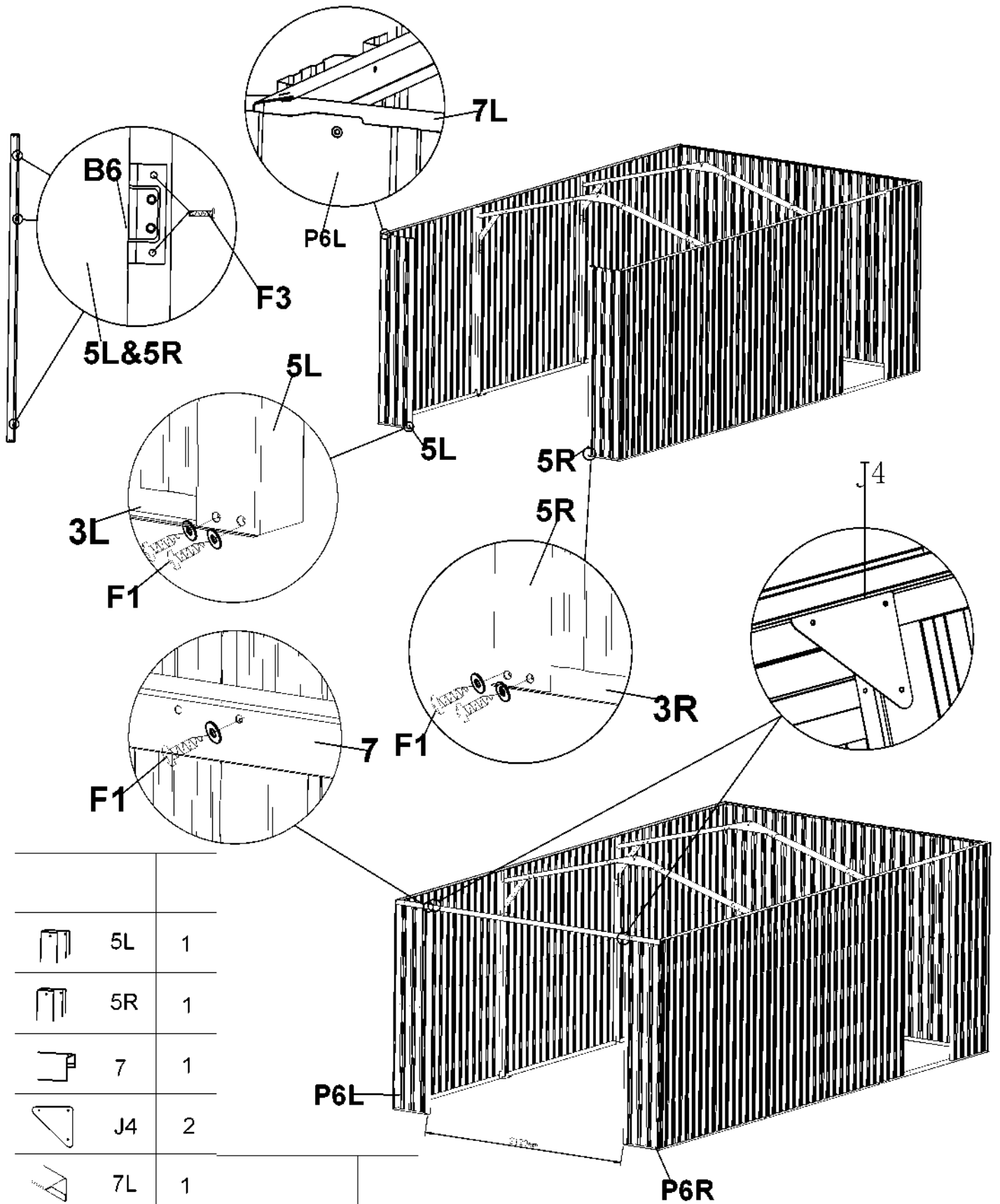

	F2

Asenna tukirakenne oikein (muista seinäasennuksessa mainittu 7–8 cm:n väli). Kiinnitä tukikehykset paneeleihin ruuveilla F2.

# OVENKARMIN KOKOAMINEN



	5L	1		
	5R	1		
	7	1		
	J4	2		
	7L	1		
	7R	1		B6 6
	F1			F3



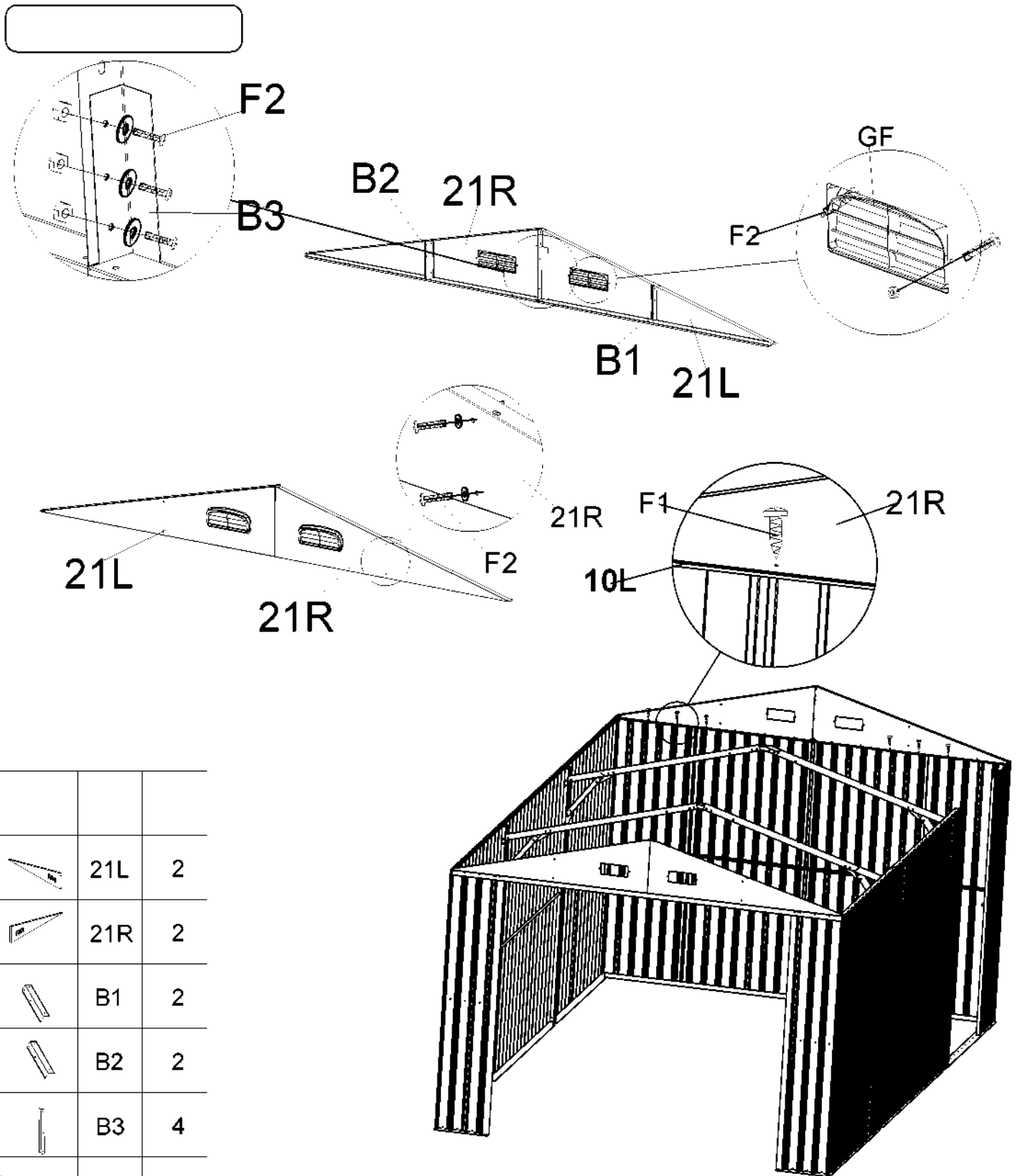

# PÄÄTYKOLMIOIDEN ASENNUS

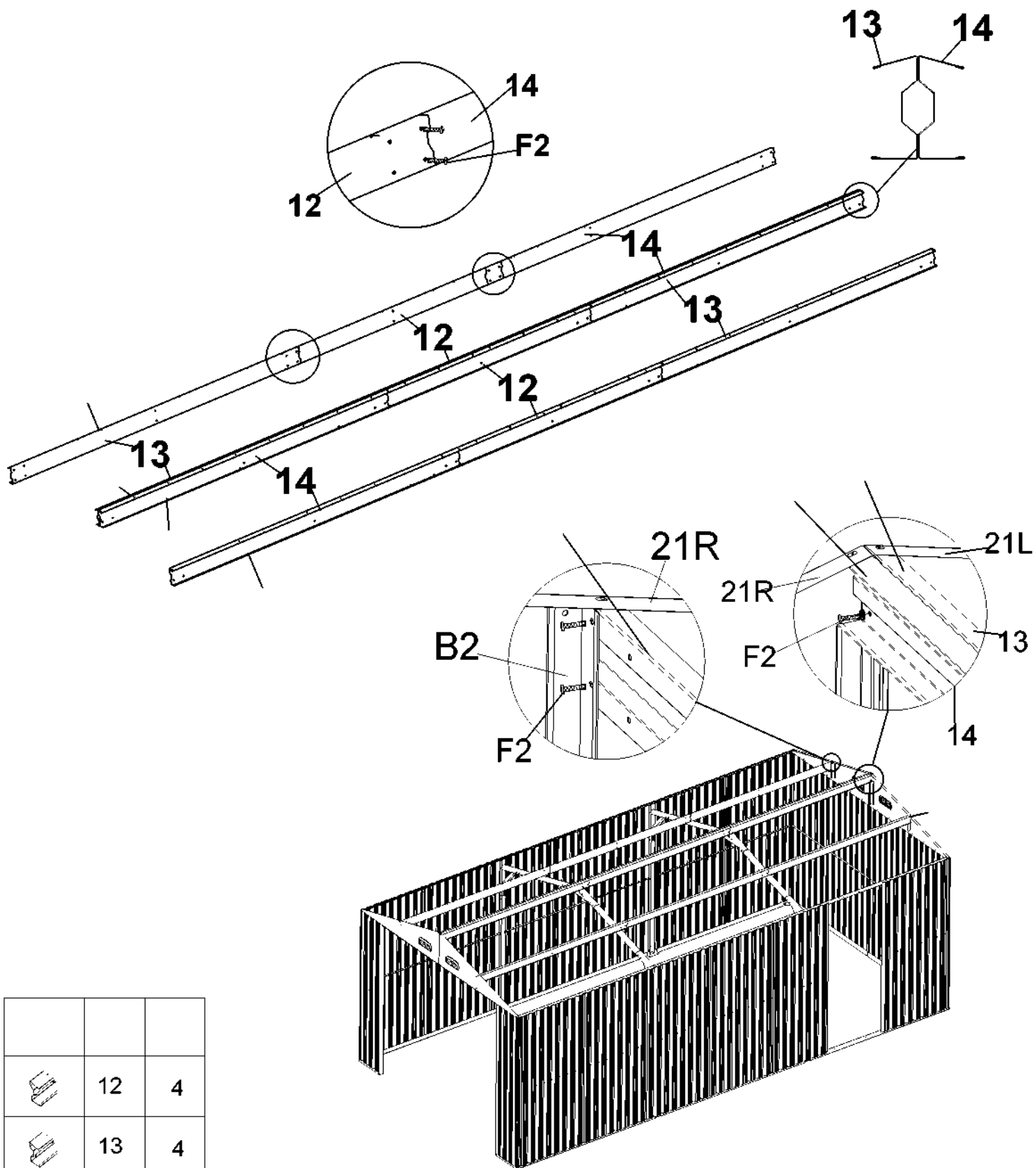

	21L	2
	21R	2
	B1	2
	B2	2
	B3	4
	GF	4
	F1	
	F2	

# OVENKARMIN KOKOAMINEN



	12	4
	13	4
	14	4
	F2	

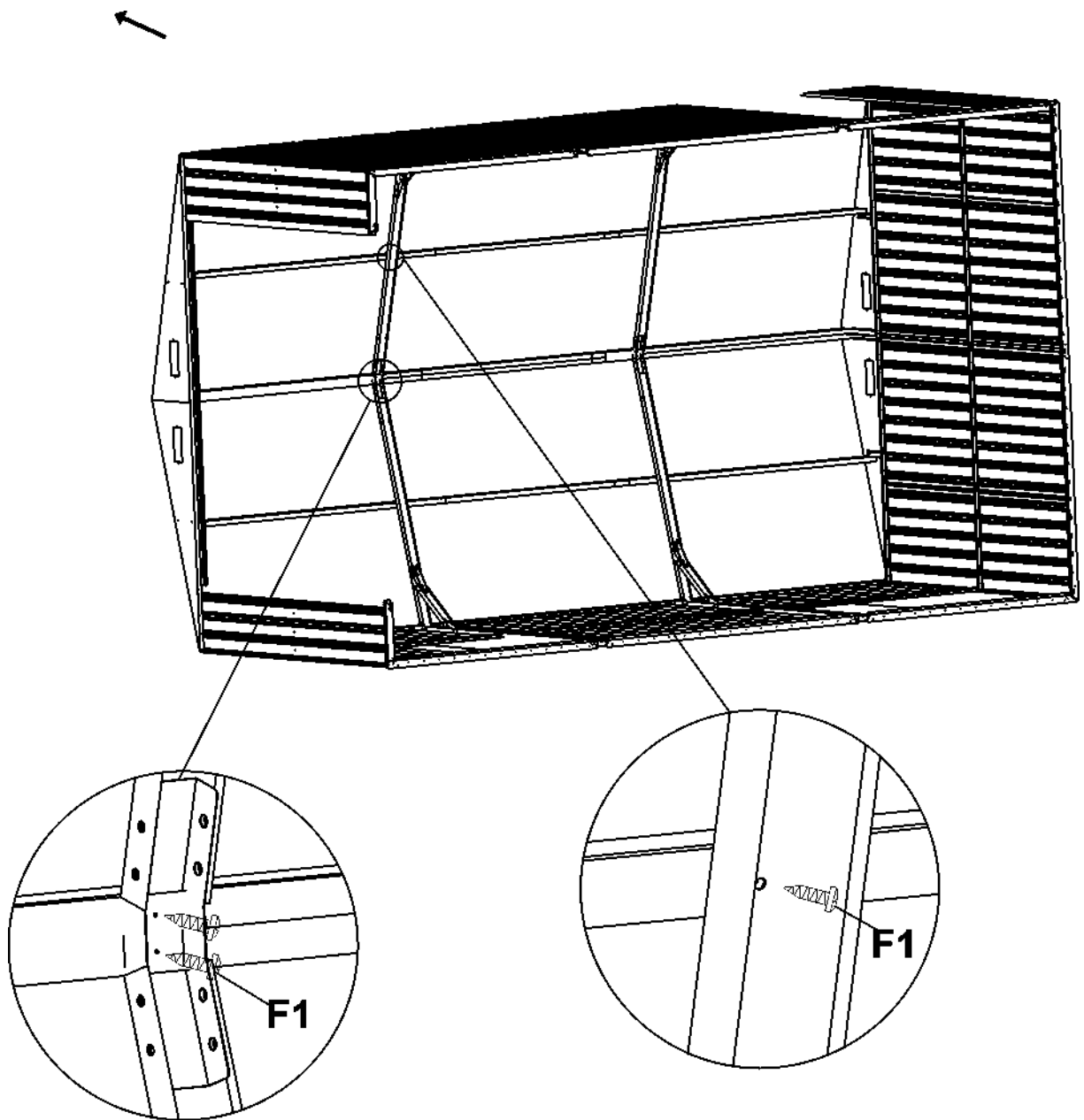

# YLÄPALKIN VAHVISTAMINEN 1



 F1	

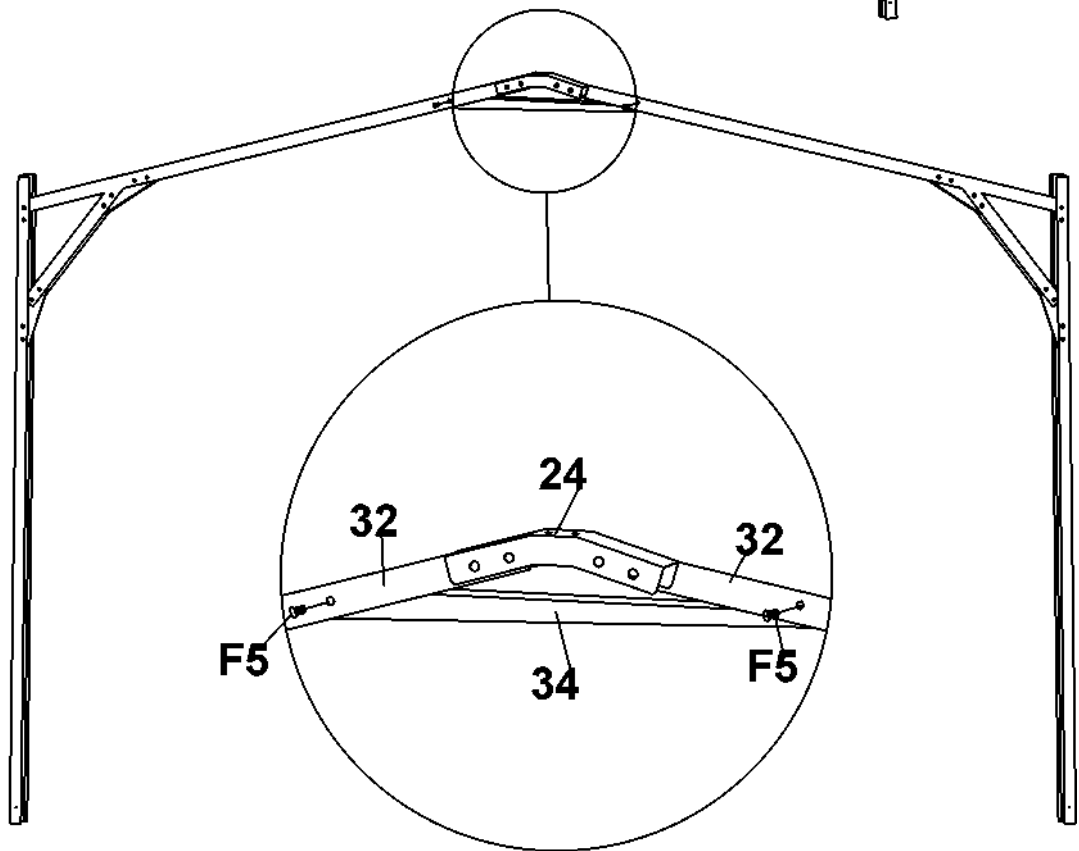
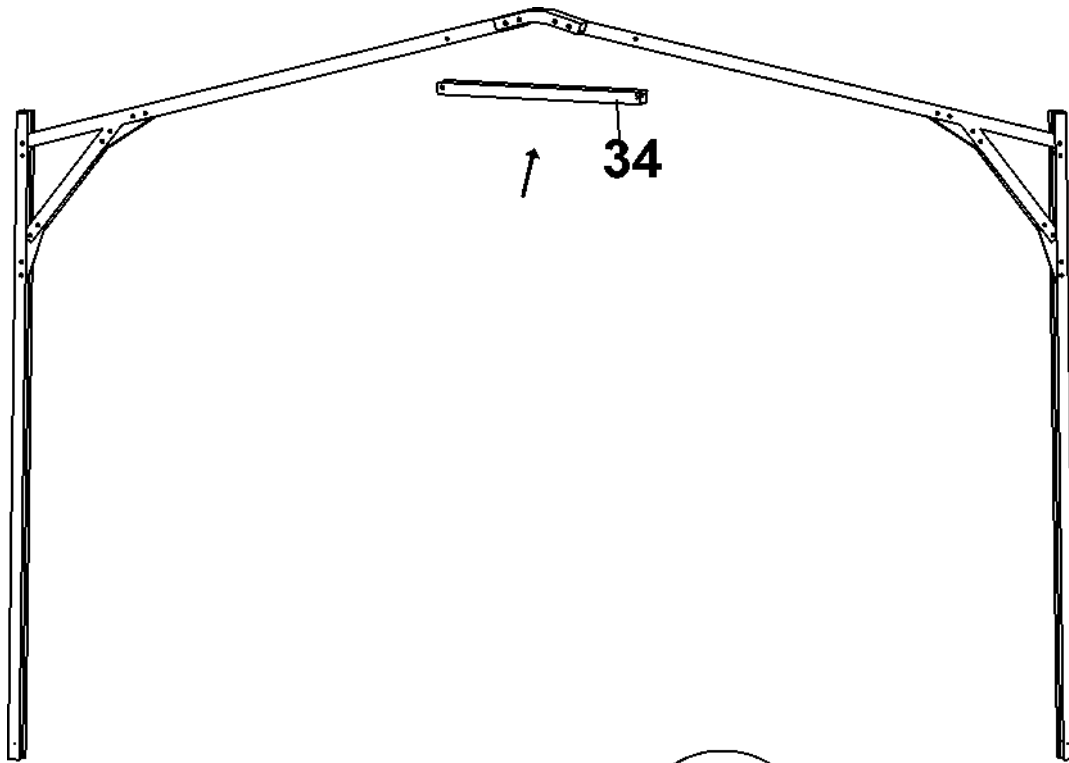

# YLÄPALKIN VAHVISTAMINEN 2



	34	2
	F5	

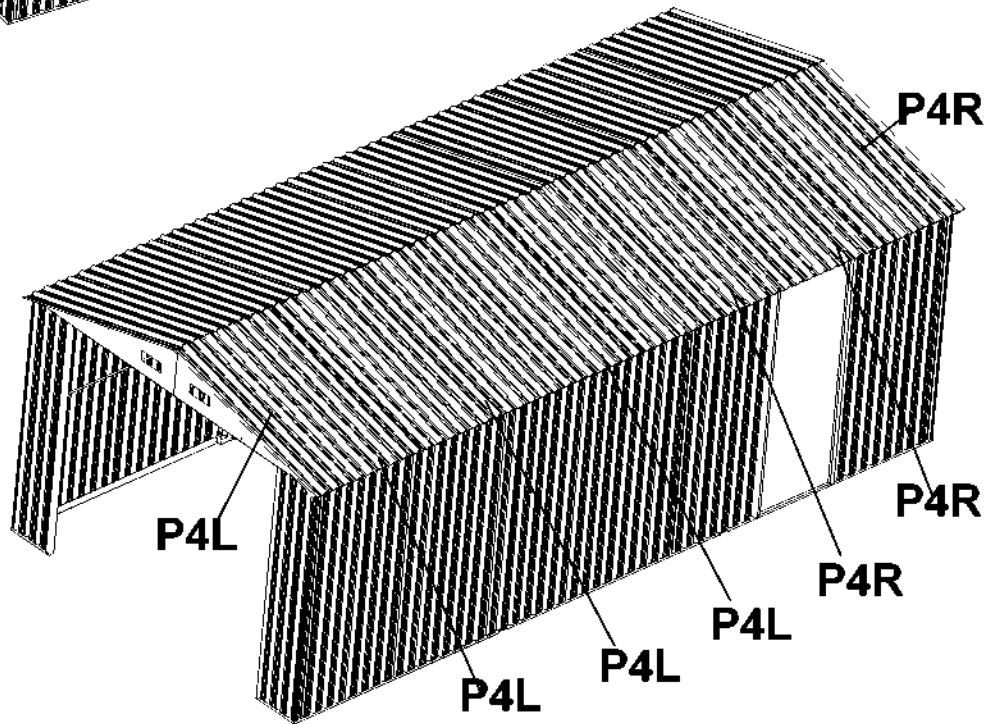
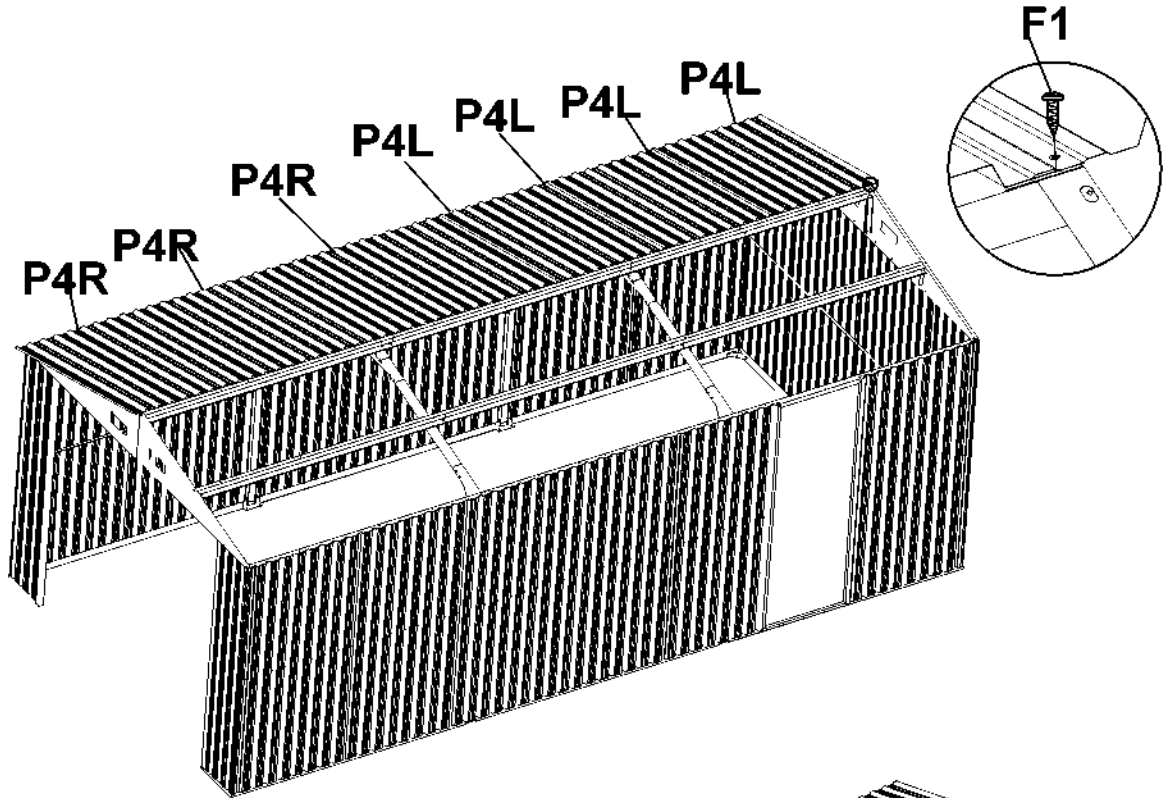
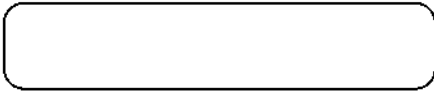





# KATTOPANEELIEN ASENNUS

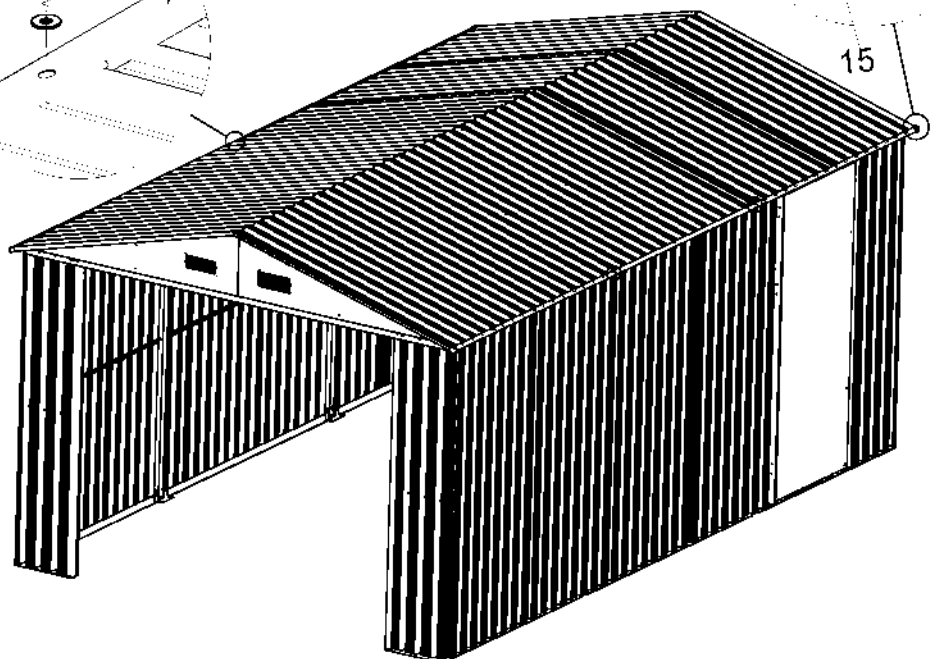
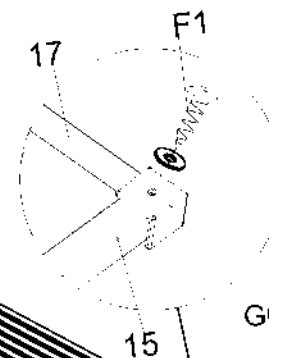
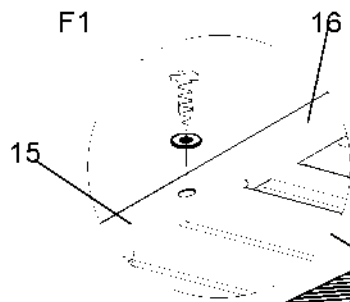
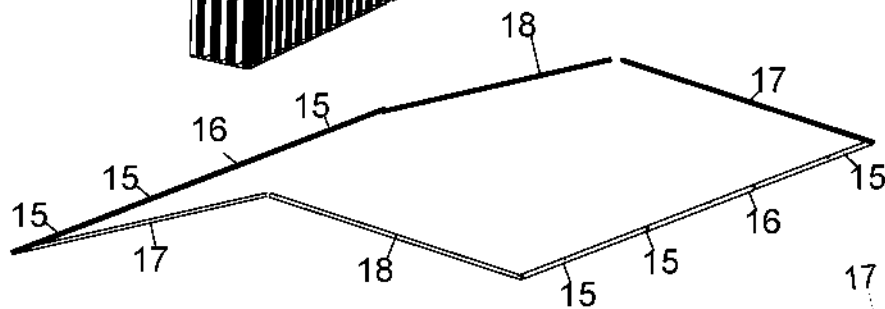
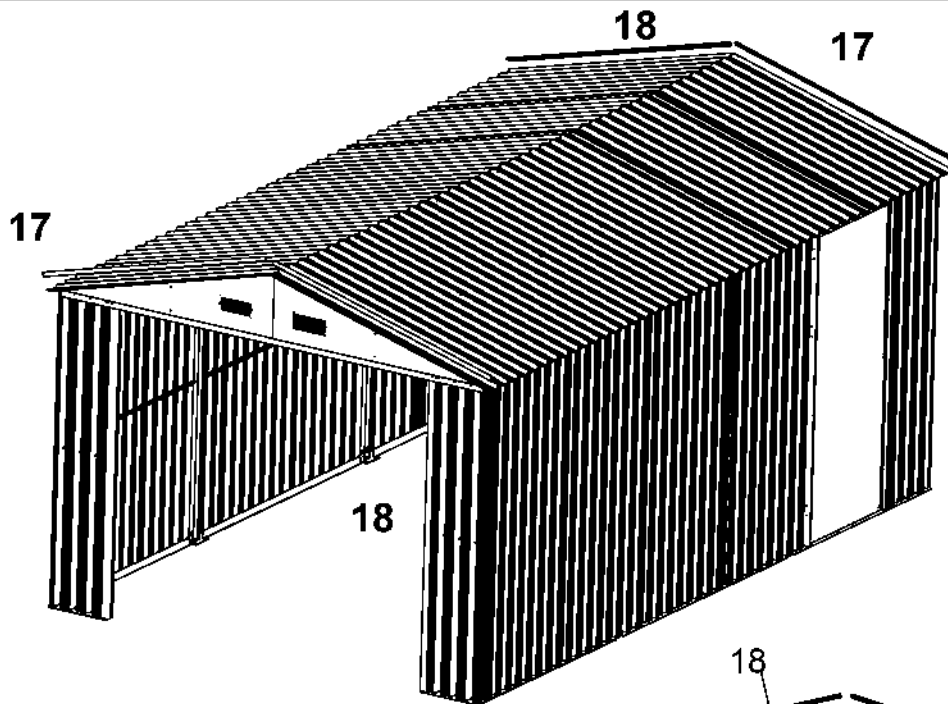

	P4L	8
	P4R	6
	F1	

# REUNAPELLITYKSEN ASENNUS





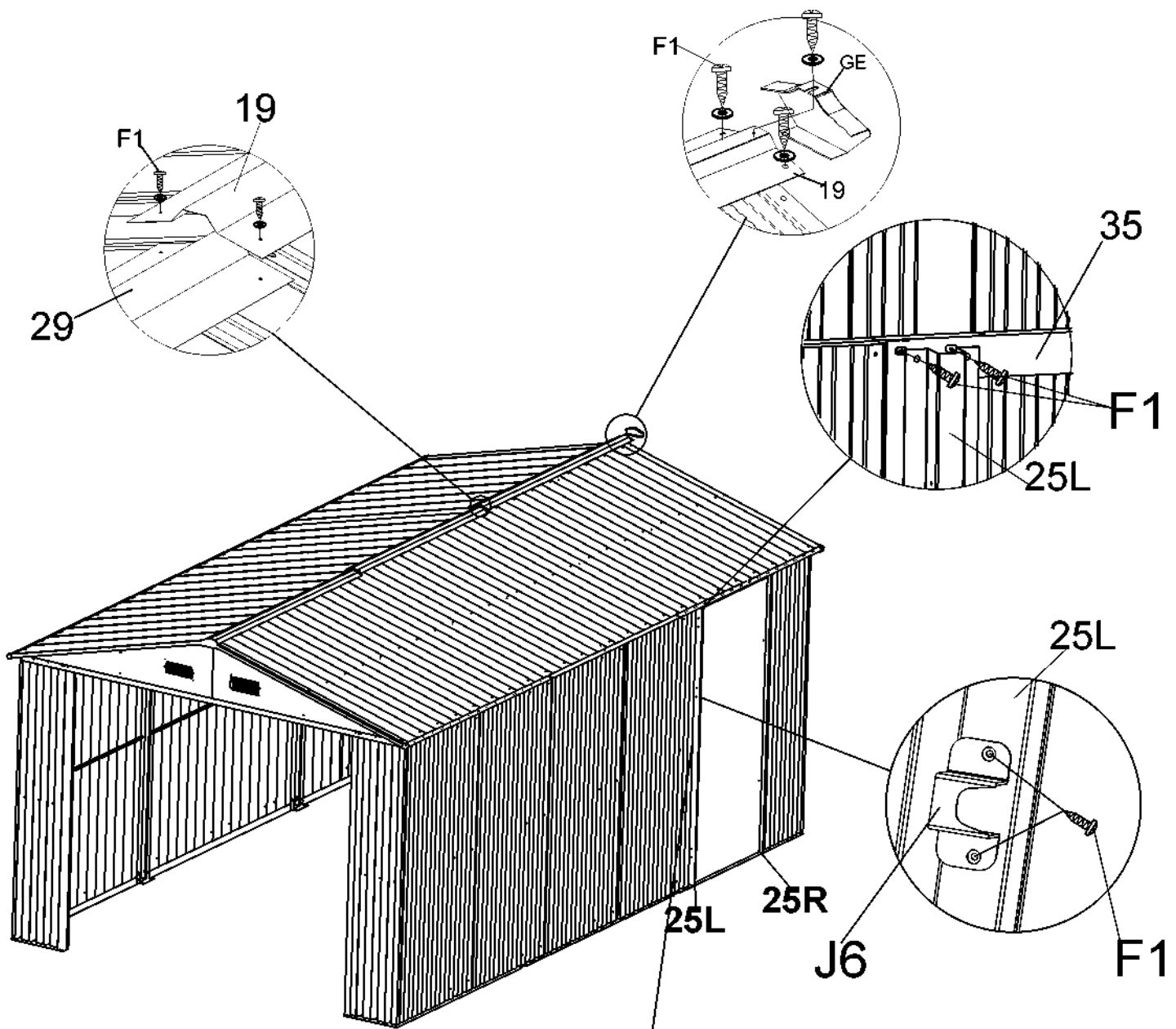



	15	6
	16	2
	17	2
	18	2
	GC	4
	F1	

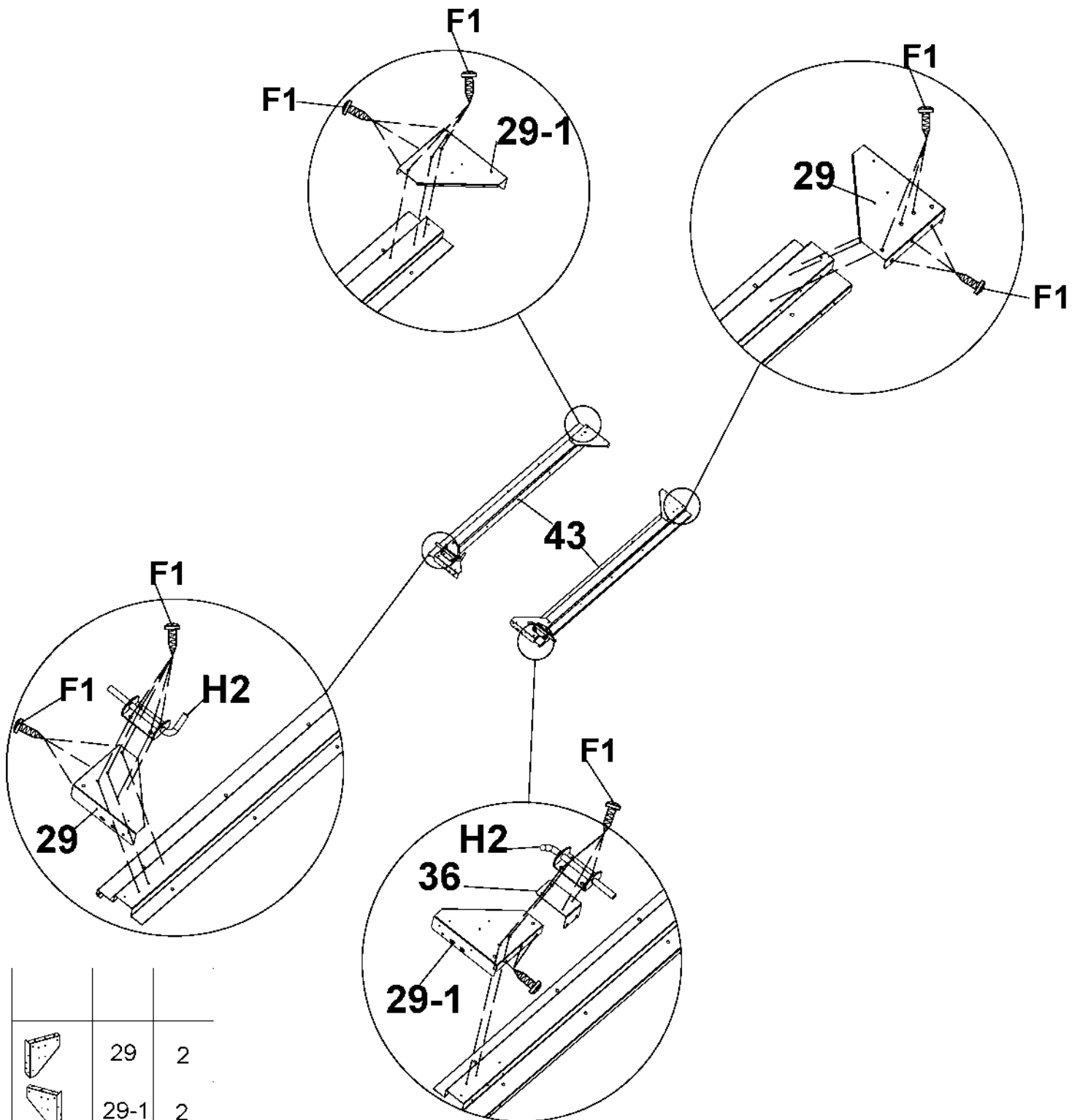

	19	7			
	GE	2			
	F1				
	25L	1			
	25R	1			
	F2	1			
	J6	1		35	1

# OVEN ASENNUS 1



	29	2
	29-1	2
	43	2
	H2	2
	36	1
	F1	

# OVEN ASENNUS 2

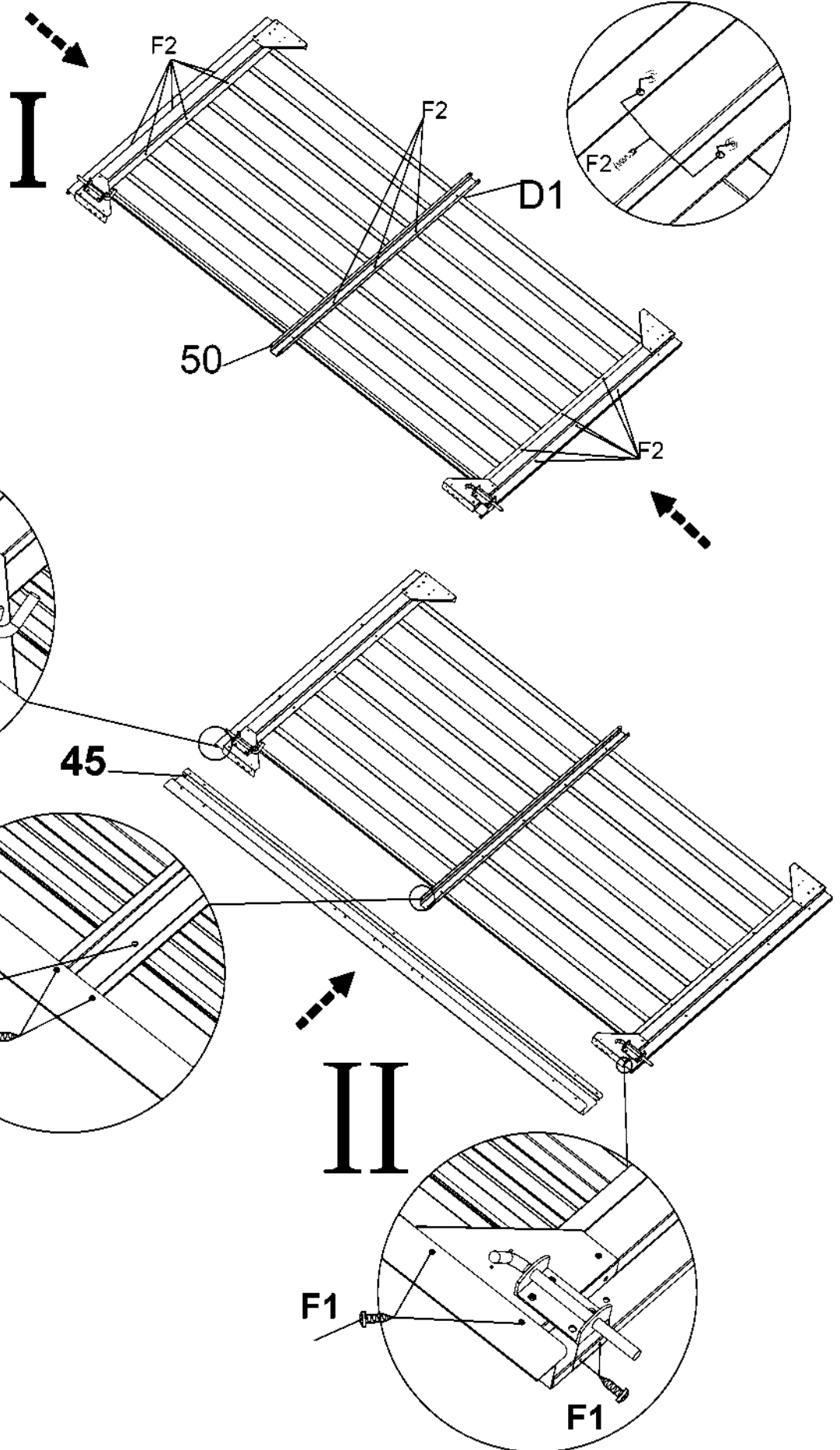

	45	1
	50	1
	D1	1
	F2	
	F1	

# OVEN ASENNUS 3

## I

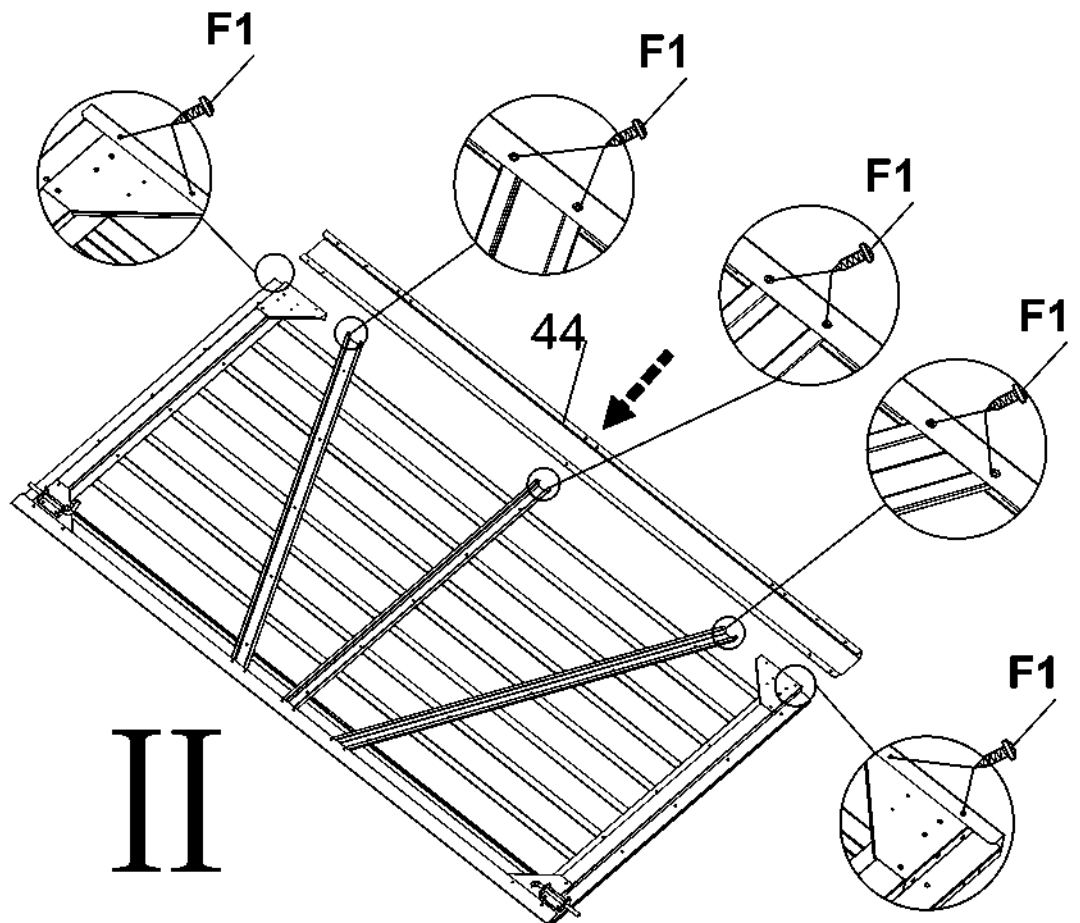
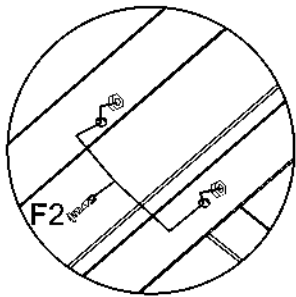
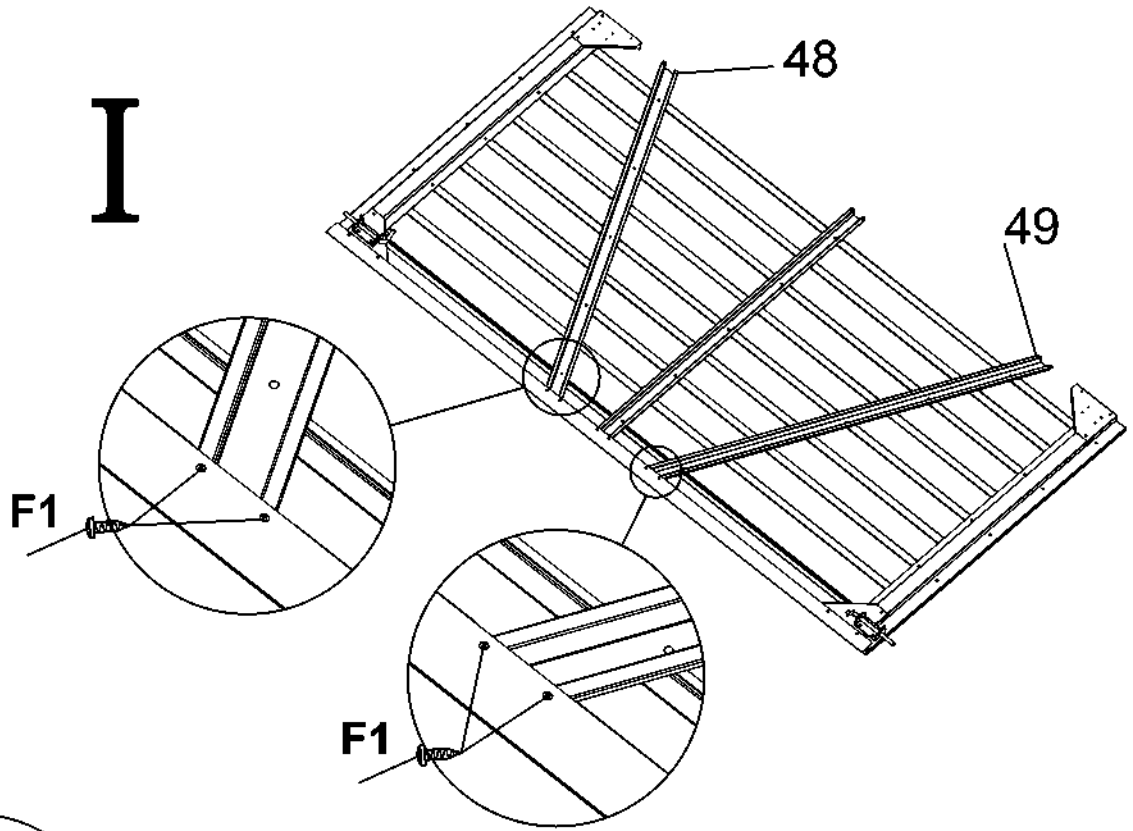



	48	1
	49	1
	44	1
	F1	

## II

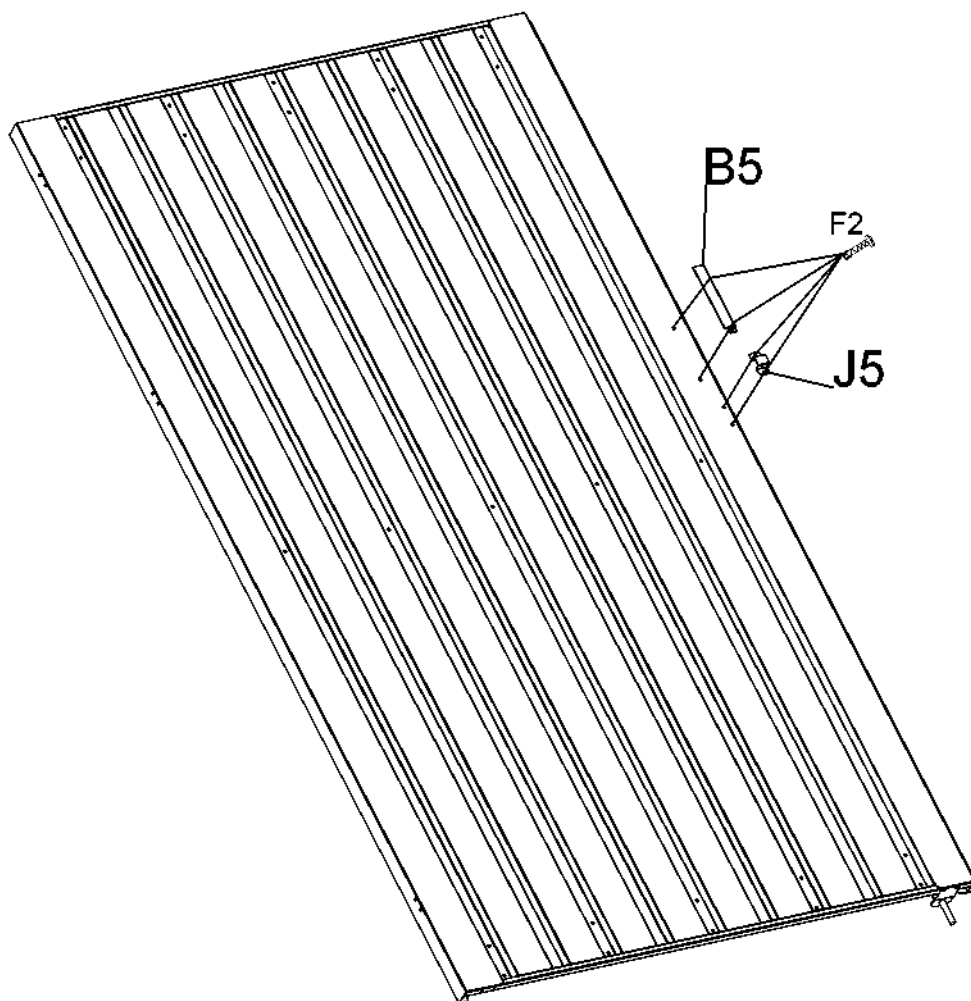
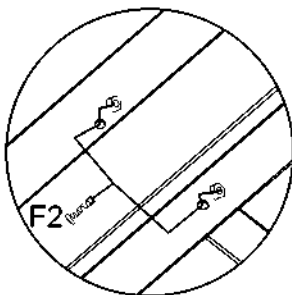

# OVEN ASENNUS 4



	B5	1
	J5	1
	F2	

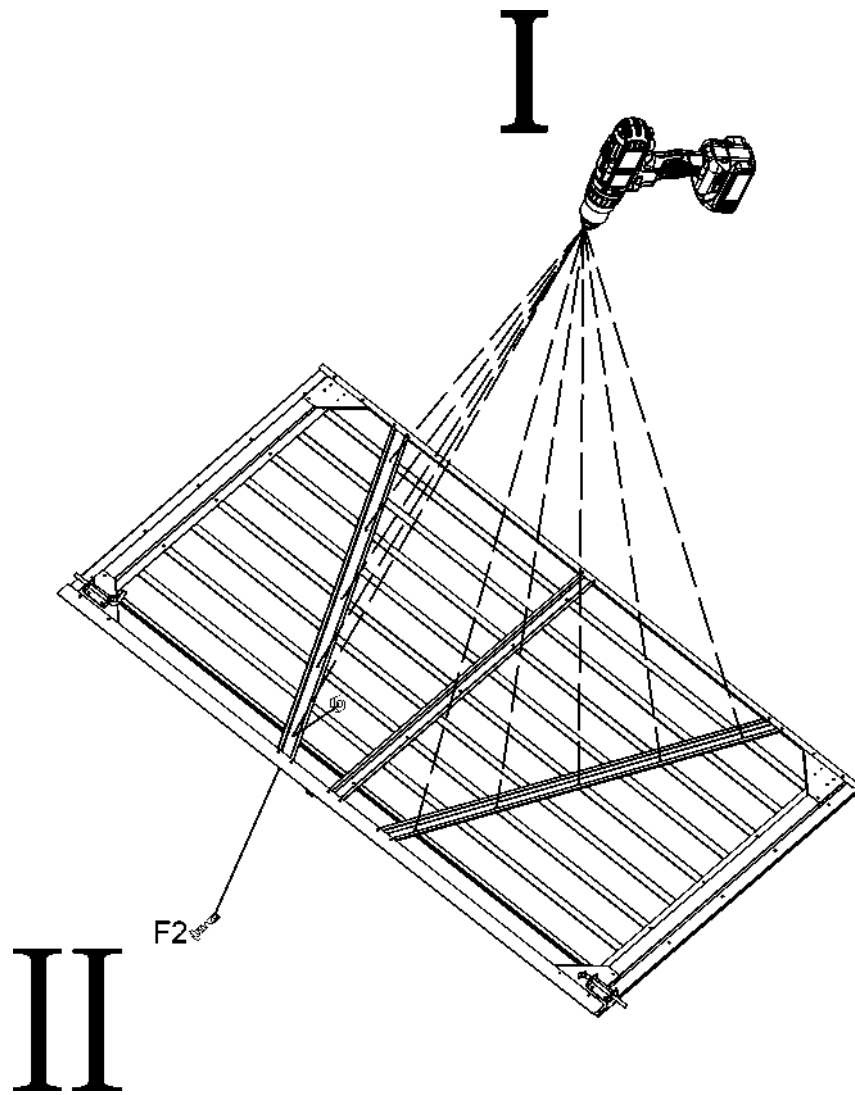

# OVEN ASENNUS 5



 	F2	
		

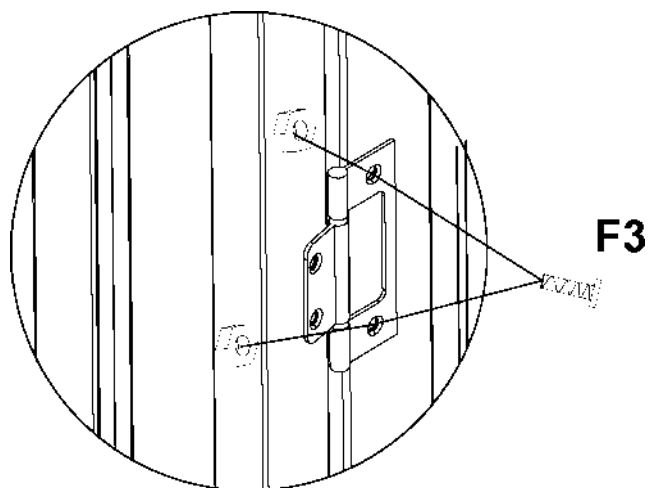
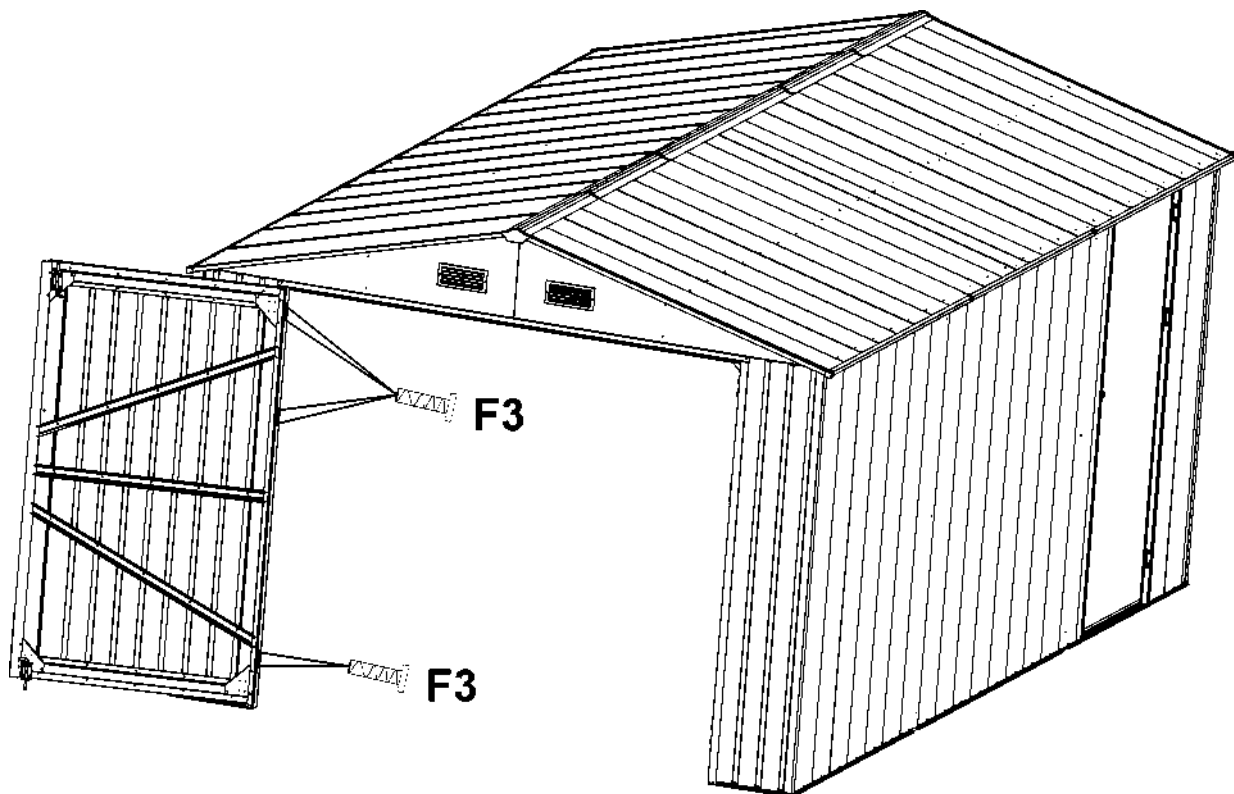



# OVEN ASENNUS 6

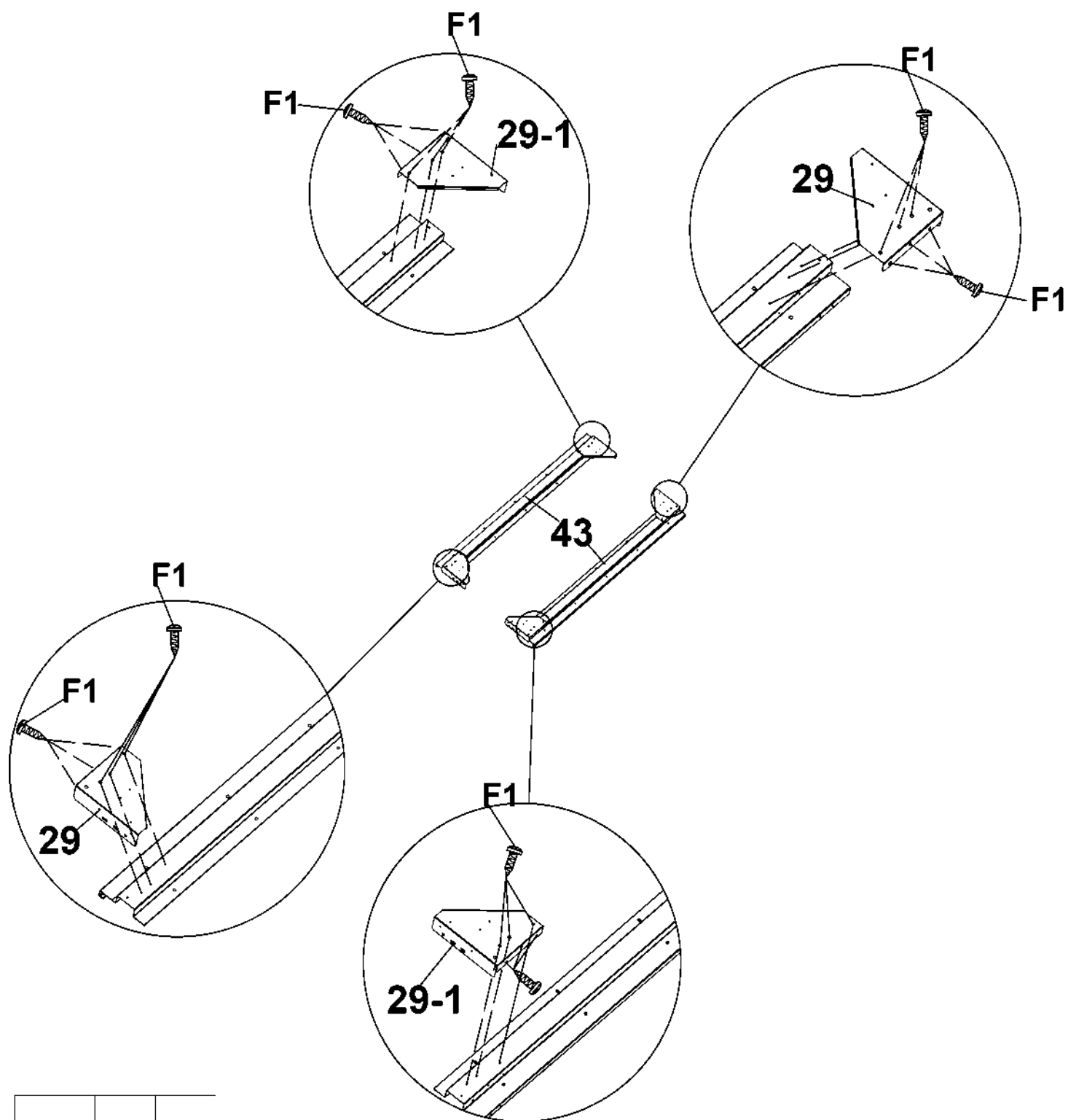

		F3

# OVEN ASENNUS 7



	29	2
	29-1	2
	43	2
	F1	

# OVEN ASENNUS 8

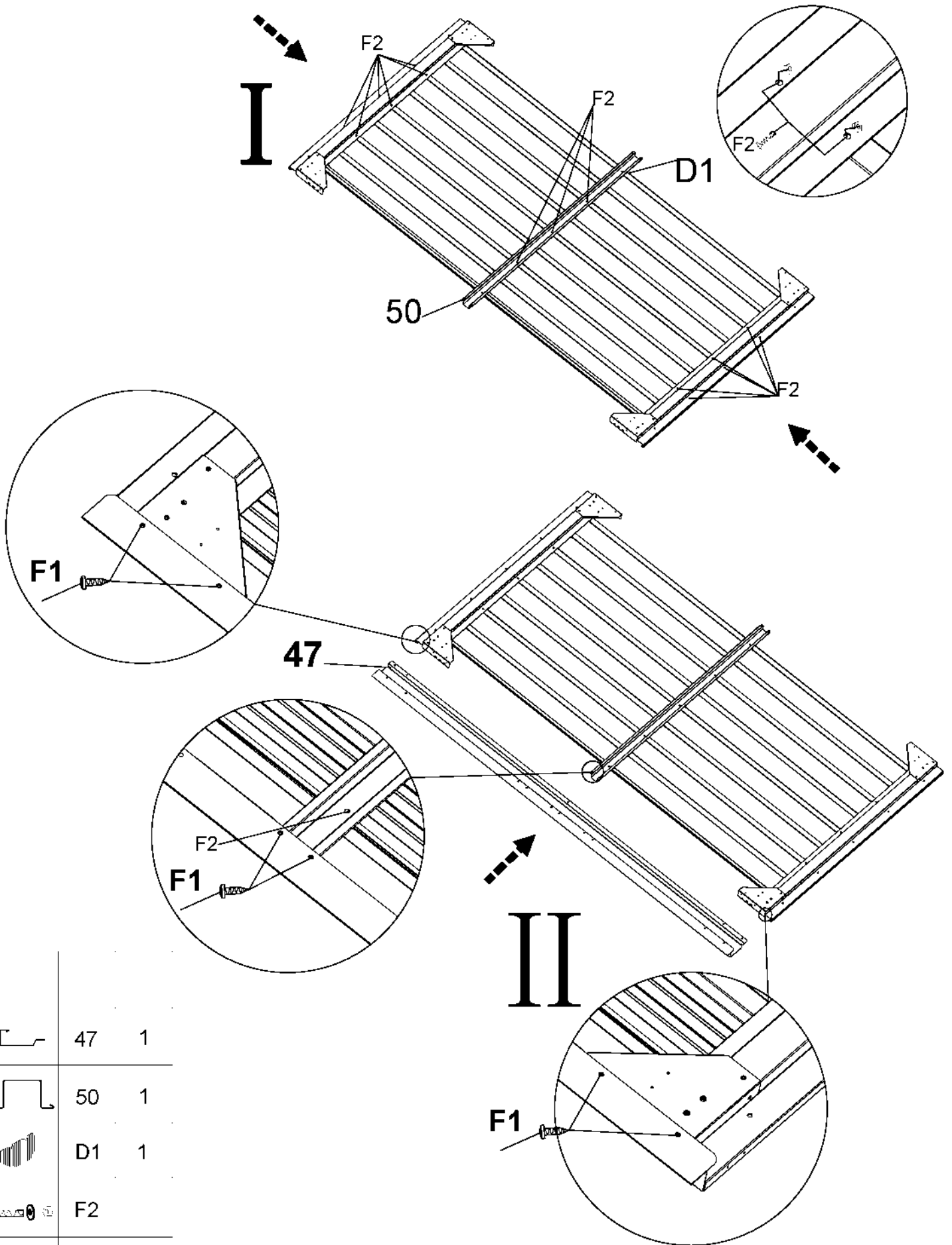

	47	1
	50	1
	D1	1
	F2	
	F1	

# OVEN ASENNUS 9

## I

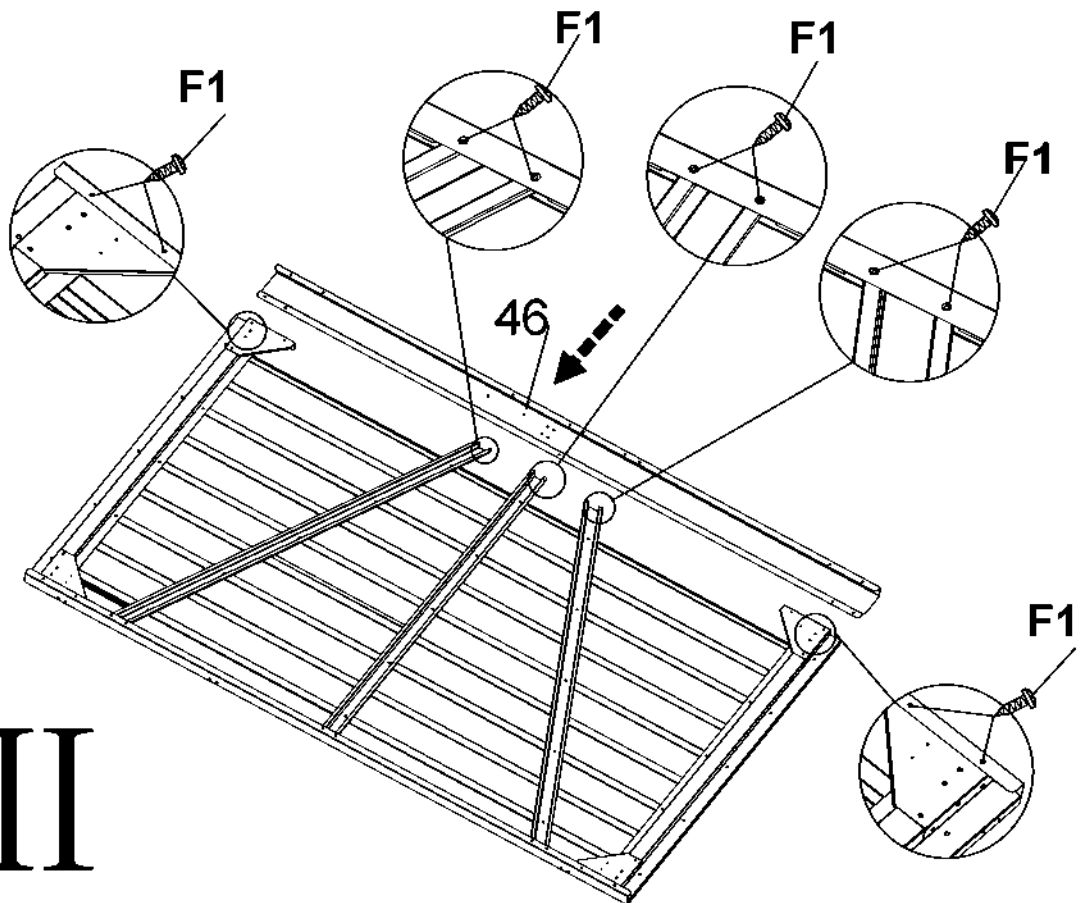
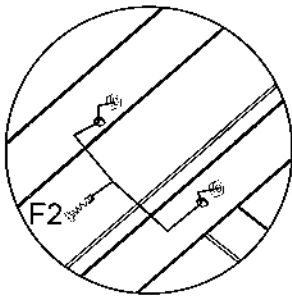
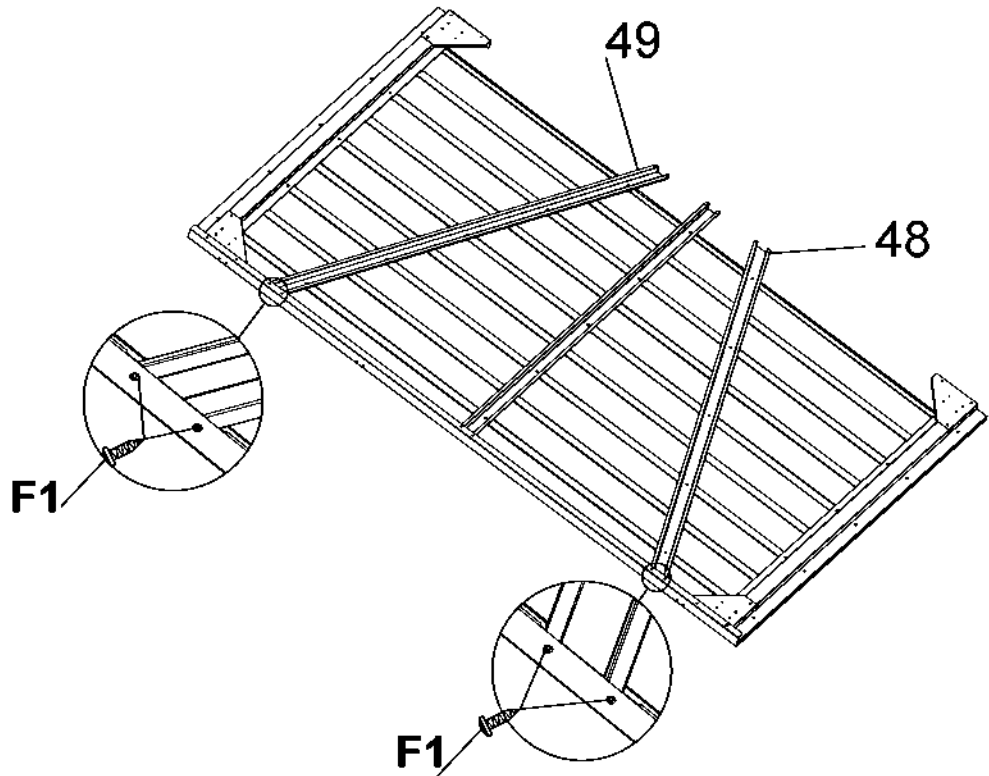

	48	1
	49	1
	46	1
	F1	

## II

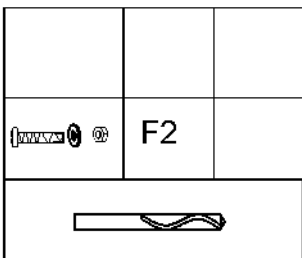
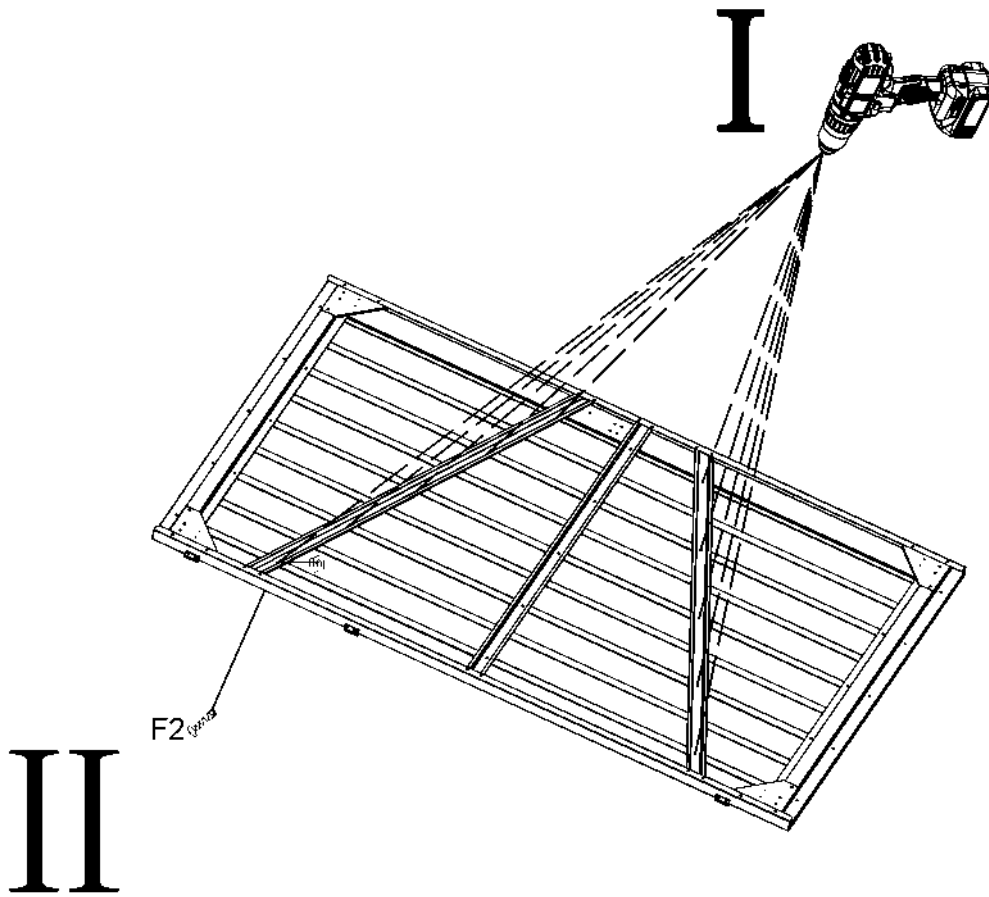

# OVEN ASENNUS 10



Kiinnitä osat B5, H1 ja H2 oven etupuolelle ruuveilla (F1).

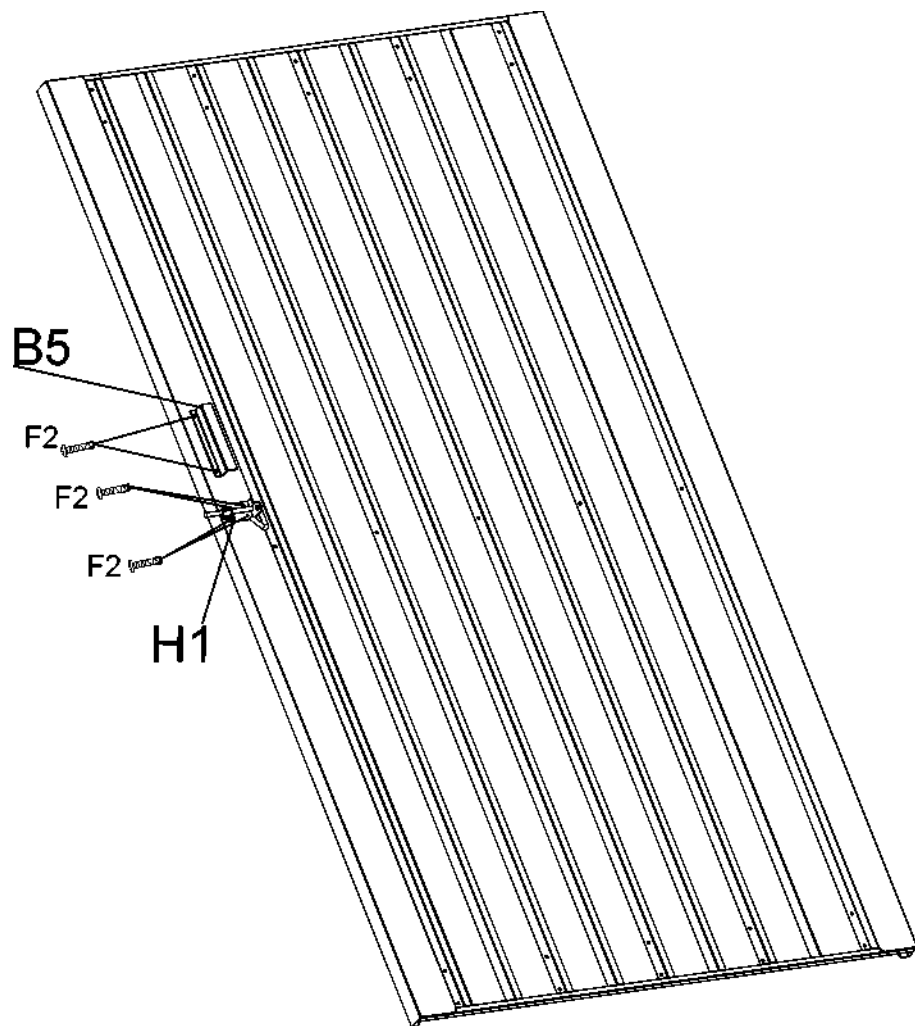

# OVEN ASENNUS 11



	B5	1
	H1	1
	F2	

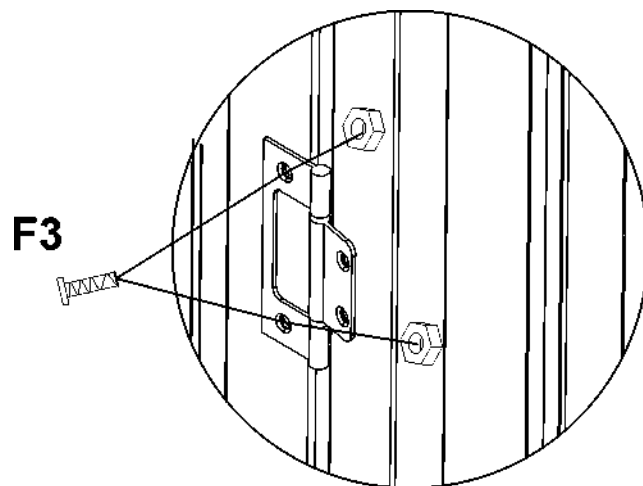
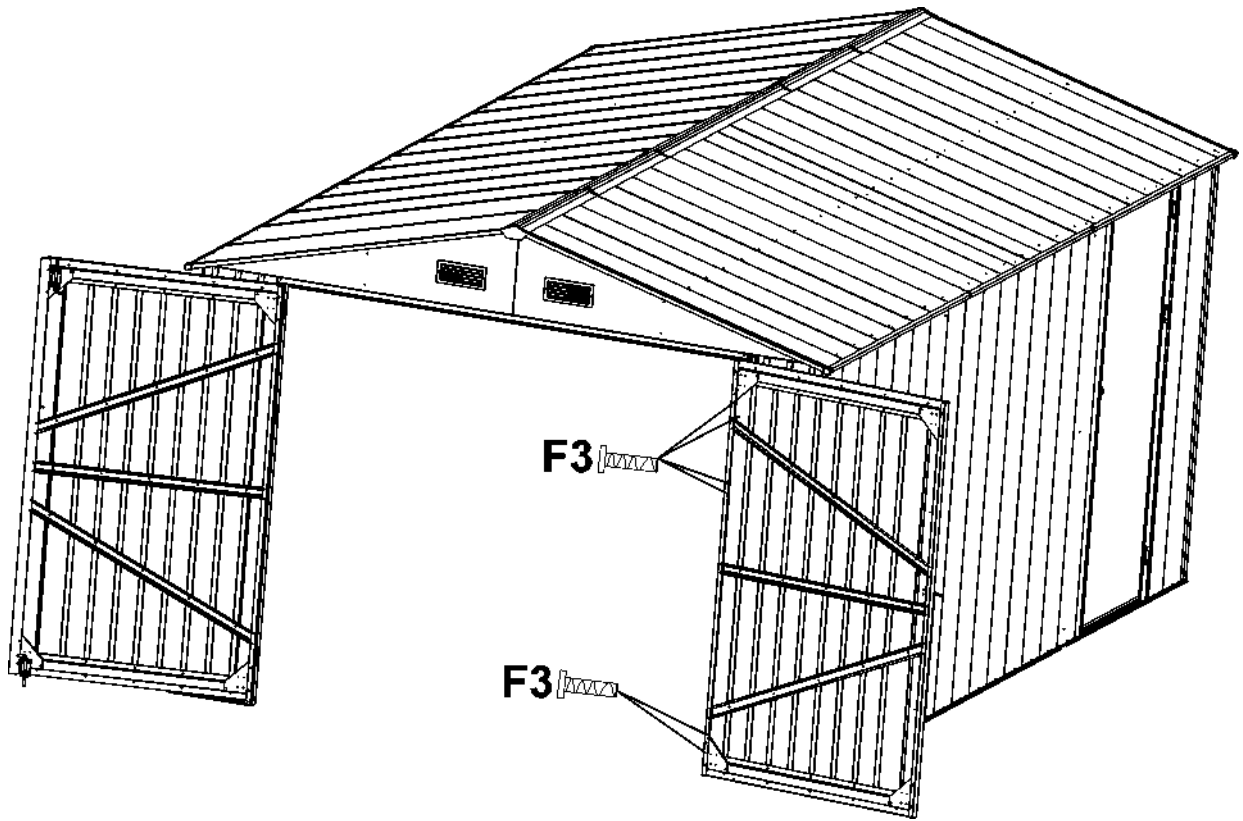

# OVEN ASENNUS 12

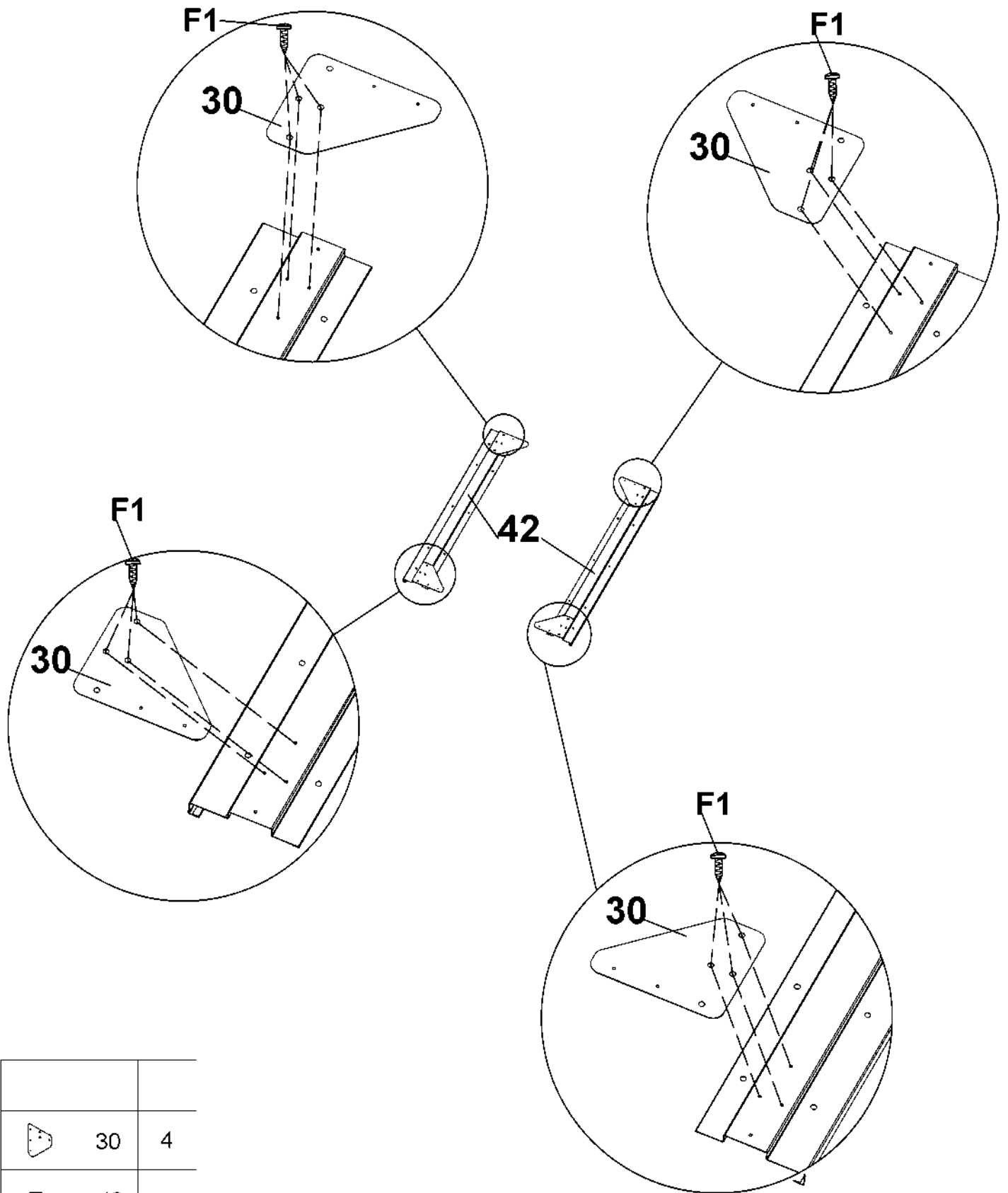

		F3

# OVEN ASENNUS 13





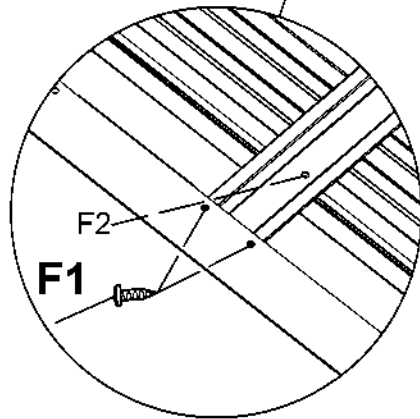
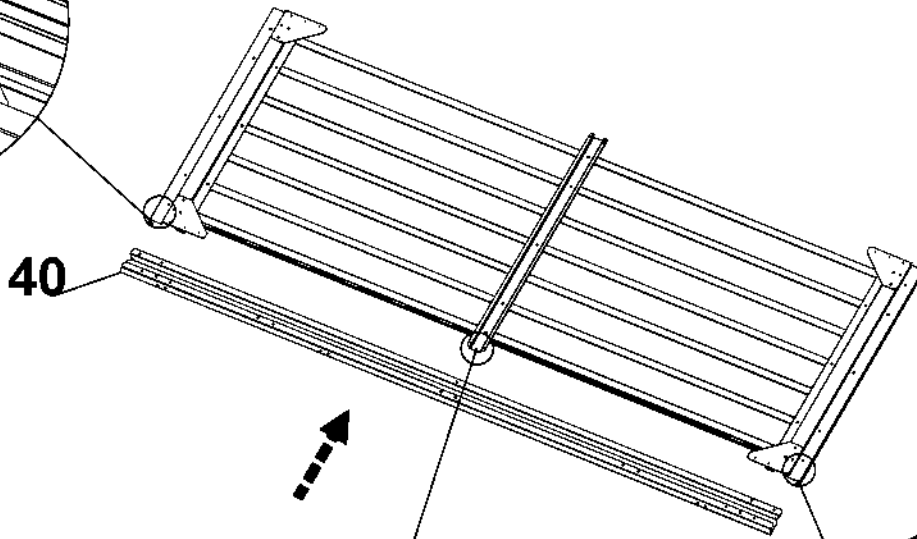
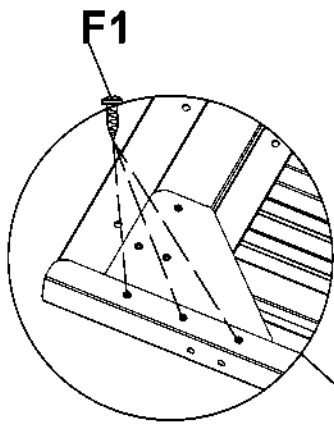
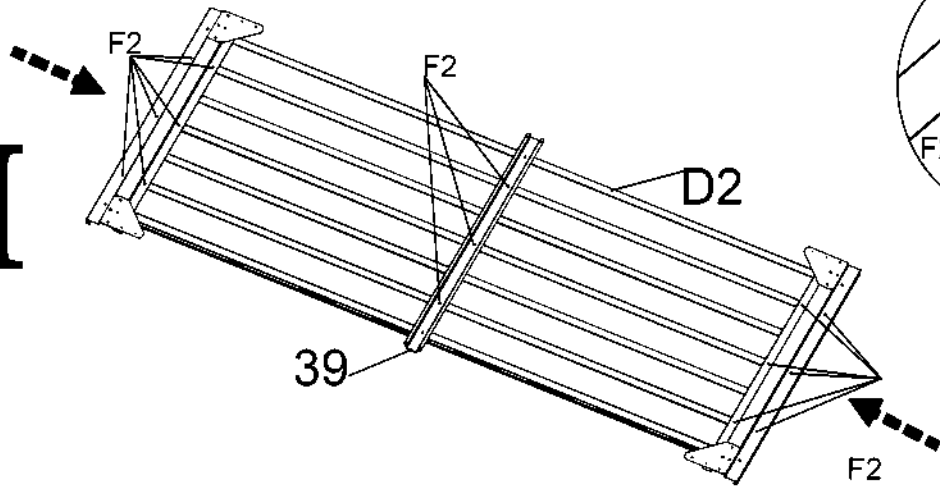

	30	4
	42	2
	F1	

# OVEN ASENNUS 14

## I



## II



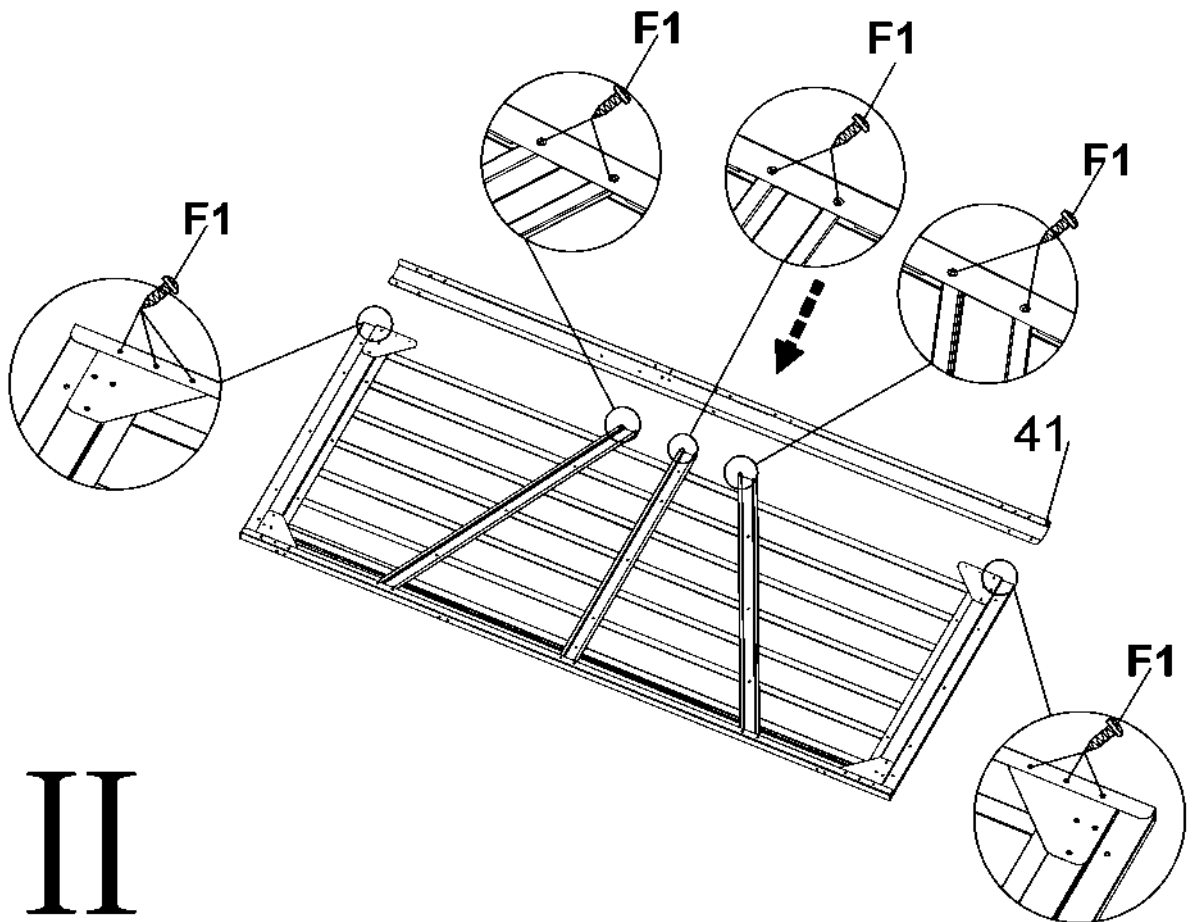
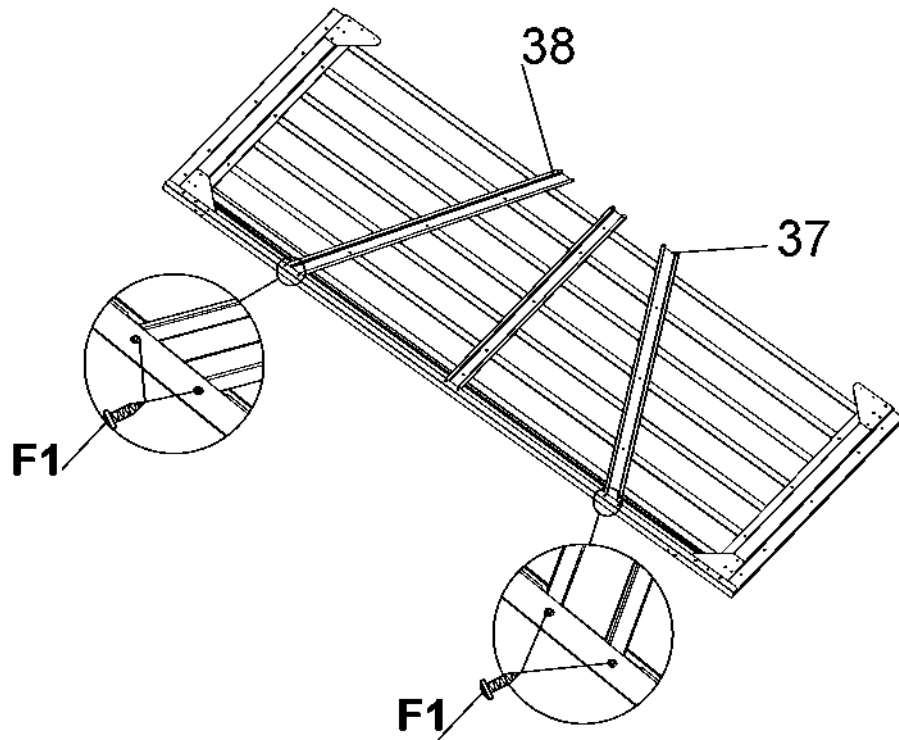

	40	1
	39	1
	D2	1
	F2	
	F1	

# OVEN ASENNUS 15

## I

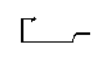

## II

	37	1
	38	1
	41	1
	F2	
	F1	

# OVEN ASENNUS 16

## I

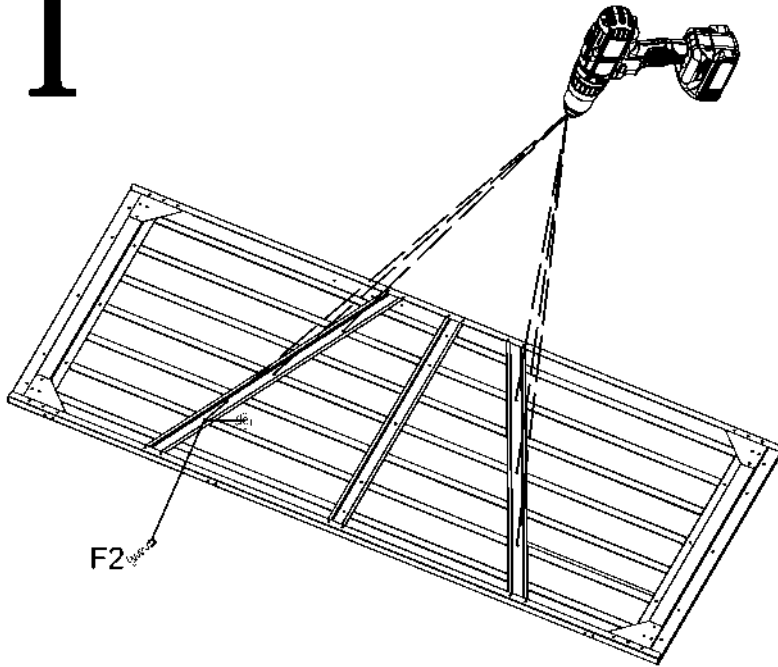



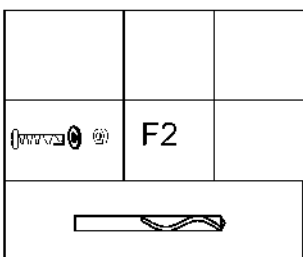

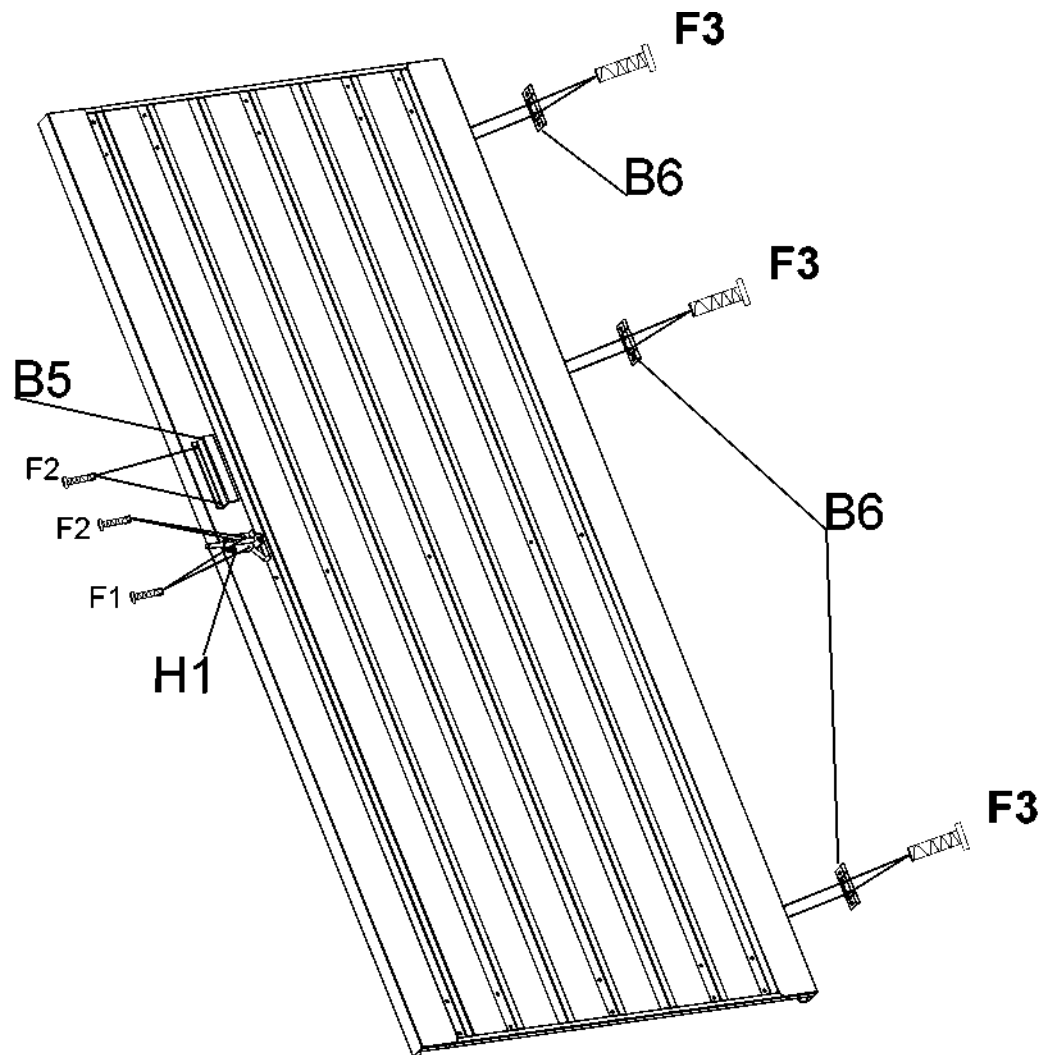

## II



# OVEN ASENNUS 17



	B5	1
	B6	3
	H1	1
	F3	
	F2	
	F1	

# OVEN ASENNUS 18

